



**2019**

**PLASTİK ÜRÜNLER KATALOĞU**  
**PLASTIC PRODUCTS CATALOGUE**

[www.hipas.com.tr](http://www.hipas.com.tr)



### PLASTİK TAŞIMA KASALARI

PLASTIC CARRYING CRATES

3 - 29



### PLASTİK KASALAR

PLASTIC CRATES

3 - 16

### KATLANIR KASALAR

FOLDING CRATES

18 - 19



### KONİK KASALAR

NESTABLE CRATES

20 - 21



### KONTEYNERLAR

CONTAINERS

24 - 27

### KATLANIR KONTEYNERLAR

FOLDING CONTAINERS

28 - 29



### PLASTİK PALETLER

PLASTIC PALLETS

30 - 33



### ESD ANTİSTATİK ÜRÜNLER

ESD CONDUCTIVE PRODUCTS

34 - 37



### ÇÖP KOVALARI

WASTE BINS

38 - 40



### PLASTİK RAF KUTULARI

PLASTIC SHELF BINS

41



### PLASTİK ÇEKMECELİ KUTULAR

PLASTIC DRAWER BOXS

42 - 47



### PLASTİK AVADANLIK KUTULAR

PLASTIC STACKING BINS

48 - 51



### PLASTİK TAKIM ÇANTALARI

PLASTIC TOOL BOXES

52 - 53



### PLASTİK ORGANİZER KUTULAR

PLASTIC ORGANIZER BOXES

54 - 55



### PLASTİK ŞEFFAF KUTULAR VE SAKLAMA KAPLARI

PLASTIC CLEAR BOXES AND STORAGE BOXES

56



### PLASTİK RÖGAR KUTULARI

PLASTIC MANHOLE BOXES

57



### TRAFİK GÜVENLİĞİ ÜRÜNLERİ

TRAFFIC SAFETY PRODUCTS

58 - 64



### PLASTİK EVRAK TUTUCULAR

PLASTIC DOCUMENT HOLDERS

68

### R-KLT ve RL-KLT Kasalar

PPC'den üretilen KLT kasa serisi yüksek dayanma gücüne sahip olmakla birlikte otomotiv, yan sanayi, ağır sanayi ve birçok sektörde kullanılmaktadır. R-KLT (güçlü taban) ve RL-KLT (düz taban) olmak üzere iki taban seçeneği ile üretilmektedir.

El tutma yerlerinin kapalı olması sayesinde daha ergonomik ve güvenli taşınabilmektedir. Tüm seride standart olarak etiket tutucu bulunmaktadır.

### R-KLT & RL-KLT Crates

The KLT crate series are produced from PPC and have high durability. They are used in automotive, sub-industry, heavy industry and many other sectors. R-KLT (reinforced base), RL-KLT (flat base) are produced with two base options. With closed hand grips, crates are more ergonomic and can be carried safely. All serie have standart label pocket.

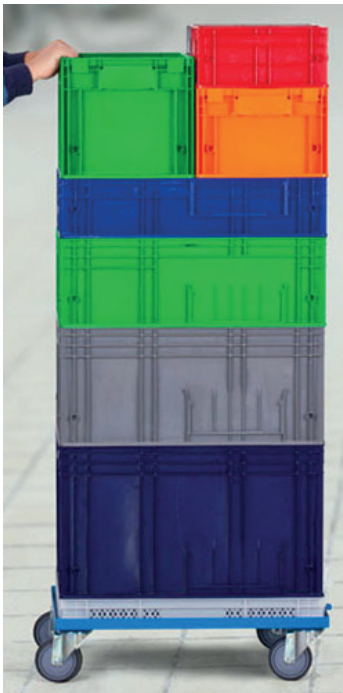

**YM-4060**

Dış / Ext 420 x 620 x 150 mm

Metal Kasa Taşıyıcı

Metal dolly

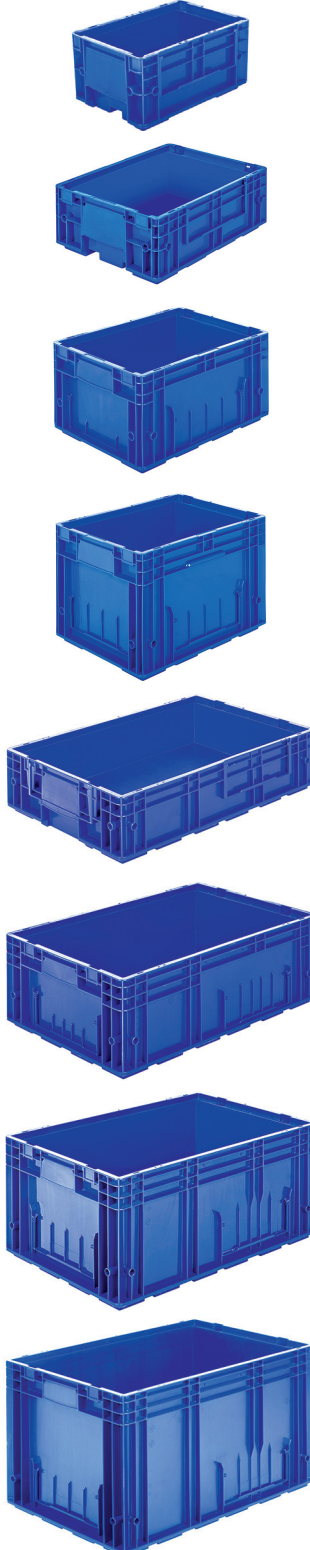

**Güçlendirilmiş Taban**  
Reinforced Base



**Düz Taban**  
Flat Base

Kod / Code	<b>R-KLT-3215</b> En/W Boy/L Yük/H	<b>RL-KLT-3147</b> En/W Boy/L Yük/H
Dış / Ext	200 x 300 x 147 mm	200 x 300 x 147 mm
İç / Int	170 x 245 x 125 mm	170 x 245 x 143 mm
Kod / Code	<b>R-KLT-4315</b> En/W Boy/L Yük/H	<b>RL-KLT-4147</b> En/W Boy/L Yük/H
Dış / Ext	300 x 400 x 147 mm	300 x 400 x 147 mm
İç / Int	265 x 340 x 120 mm	265 x 340 x 143 mm
Kod / Code	<b>R-KLT-4322</b> En/W Boy/L Yük/H	<b>RL-KLT-4213</b> En/W Boy/L Yük/H
Dış / Ext	300 x 400 x 215 mm	300 x 400 x 215 mm
İç / Int	265 x 340 x 195 mm	265 x 340 x 211 mm
Kod / Code	<b>R-KLT-4329</b> En/W Boy/L Yük/H	<b>RL-KLT-4280</b> En/W Boy/L Yük/H
Dış / Ext	300 x 400 x 280 mm	300 x 400 x 280 mm
İç / Int	265 x 340 x 255 mm	265 x 340 x 276 mm
Kod / Code	<b>R-KLT-6415</b> En/W Boy/L Yük/H	<b>RL-KLT-6147</b> En/W Boy/L Yük/H
Dış / Ext	400 x 600 x 147 mm	400 x 600 x 147 mm
İç / Int	364 x 544 x 109 mm	364 x 544 x 143 mm
Kod / Code	<b>R-KLT-6422</b> En/W Boy/L Yük/H	<b>RL-KLT-6213</b> En/W Boy/L Yük/H
Dış / Ext	400 x 600 x 215 mm	400 x 600 x 215 mm
İç / Int	364 x 544 x 195 mm	364 x 544 x 211 mm
Kod / Code	<b>R-KLT-6429</b> En/W Boy/L Yük/H	<b>RL-KLT-6280</b> En/W Boy/L Yük/H
Dış / Ext	400 x 600 x 280 mm	400 x 600 x 280 mm
İç / Int	364 x 544 x 255 mm	364 x 544 x 276 mm
Kod / Code	<b>R-KLT-6436</b> En/W Boy/L Yük/H	<b>RL-KLT-6236</b> En/W Boy/L Yük/H
Dış / Ext	400 x 600 x 360 mm	400 x 600 x 360 mm
İç / Int	364 x 544 x 335 mm	364 x 544 x 356 mm

### 400 x 600 mm Kapalı Kasalar

Kapalı kasalar sağlam yapısı sayesinde ürünlerinizi güvenli taşımanızı , depolamanızı ve istiflemenizi sağlar. Farklı ebat, renk ve taban seçenekleri ile PPC'den üretilen kapalı kasalar isteğe göre el tutma yeri açık veya kapalı olarak tercih edebilirler.

### 400 x 600 mm Solid Crates

The solid crates allow you to carry and store your products safely with their robust structure. PPC solid crates have different size, color, base, open hand grip, closed hand grip options.



Kapalı Taban  
Closed Base



Düz Taban  
Flat Base

		Kod / Code En/W Boy/L Yük/H	<b>HP-6503</b> 400 x 600 x 65 mm	Kod / Code En/W Boy/L Yük/H	<b>HP-6504</b> 400 x 600 x 65 mm
		Dış / Ext	400 x 600 x 65 mm	Dış / Ext	400 x 600 x 65 mm
		İç / Int	365 x 565 x 53 mm	İç / Int	365 x 565 x 53 mm
		Kod / Code En/W Boy/L Yük/H	<b>HP-1003</b> 400 x 600 x 100 mm	Kod / Code En/W Boy/L Yük/H	<b>HP-1004</b> 400 x 600 x 100 mm
		Dış / Ext	400 x 600 x 100 mm	Dış / Ext	400 x 600 x 100 mm
		İç / Int	365 x 565 x 88 mm	İç / Int	365 x 565 x 88 mm
		Kod / Code En/W Boy/L Yük/H	<b>HP-1203</b> 400 x 600 x 120 mm	Kod / Code En/W Boy/L Yük/H	<b>HP-1204</b> 400 x 600 x 120 mm
		Dış / Ext	400 x 600 x 120 mm	Dış / Ext	400 x 600 x 120 mm
		İç / Int	365 x 565 x 108 mm	İç / Int	365 x 565 x 108 mm
		Kod / Code En/W Boy/L Yük/H	<b>HP-1503</b> 400 x 600 x 150 mm	Kod / Code En/W Boy/L Yük/H	<b>HP-1504</b> 400 x 600 x 150 mm
		Dış / Ext	400 x 600 x 150 mm	Dış / Ext	400 x 600 x 150 mm
		İç / Int	365 x 565 x 138 mm	İç / Int	365 x 565 x 138 mm
		Kod / Code En/W Boy/L Yük/H	<b>HP-1703</b> 400 x 600 x 170 mm	Kod / Code En/W Boy/L Yük/H	<b>HP-1704</b> 400 x 600 x 170 mm
		Dış / Ext	400 x 600 x 170 mm	Dış / Ext	400 x 600 x 170 mm
		İç / Int	365 x 565 x 158 mm	İç / Int	365 x 565 x 158 mm
		Kod / Code En/W Boy/L Yük/H	<b>HP-2003</b> 400 x 600 x 200 mm	Kod / Code En/W Boy/L Yük/H	<b>HP-2004</b> 400 x 600 x 200 mm
		Dış / Ext	400 x 600 x 200 mm	Dış / Ext	400 x 600 x 200 mm
		İç / Int	365 x 565 x 188 mm	İç / Int	365 x 565 x 188 mm
		Kod / Code En/W Boy/L Yük/H	<b>HP-2303</b> 400 x 600 x 230 mm	Kod / Code En/W Boy/L Yük/H	<b>HP-2304</b> 400 x 600 x 230 mm
		Dış / Ext	400 x 600 x 230 mm	Dış / Ext	400 x 600 x 230 mm
		İç / Int	365 x 565 x 218 mm	İç / Int	365 x 565 x 218 mm
		Kod / Code En/W Boy/L Yük/H	<b>HP-2803</b> 400 x 600 x 280 mm	Kod / Code En/W Boy/L Yük/H	<b>HP-2804</b> 400 x 600 x 280 mm
		Dış / Ext	400 x 600 x 280 mm	Dış / Ext	400 x 600 x 280 mm
		İç / Int	365 x 565 x 268 mm	İç / Int	365 x 565 x 268 mm

### 400 x 600 mm Delikli Kasalar

Delikli plastik kasalar Meyve, Sebze, Narenciye taşımacılığı, Gıda, Tarım, Market, Sanayi ve bir çok sektörde kullanılmaktadır. Farklı ebat, renk ve taban seçenekleri ile PPC'den üretilen delikli kasalar isteğe göre el tutma yeri açık veya kapalı olarak tercih edilebilirler.

### 400 x 600 mm Perforated Crates

Perforated plastic crates are used in fruits, vegetables, citrus transportation and food, agriculture, market sectors and in many other industries. PPC perforated crates have different size, color, base, open hand grip, closed hand grip options.

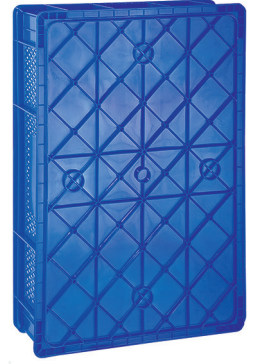
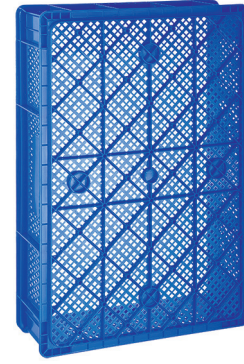

Delikli Taban  
Perforated Base

Kapalı Taban  
Closed Base

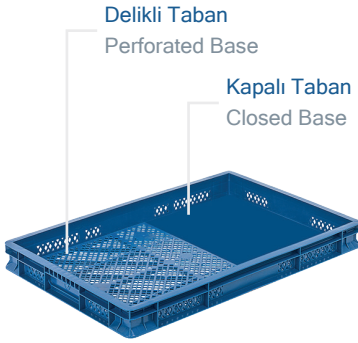

Kod / Code **HP-6501**  
En/W Boy/L Yük/H  
Dış / Ext 400 x 600 x 65 mm  
İç / Int 365 x 565 x 53 mm

Kod / Code **HP-6502**  
En/W Boy/L Yük/H  
Dış / Ext 400 x 600 x 65 mm  
İç / Int 365 x 565 x 53 mm

Kod / Code **HP-1001**  
En/W Boy/L Yük/H  
Dış / Ext 400 x 600 x 100 mm  
İç / Int 365 x 565 x 88 mm

Kod / Code **HP-1002**  
En/W Boy/L Yük/H  
Dış / Ext 400 x 600 x 100 mm  
İç / Int 365 x 565 x 88 mm

Kod / Code **HP-1501**  
En/W Boy/L Yük/H  
Dış / Ext 400 x 600 x 150 mm  
İç / Int 365 x 565 x 137 mm

Kod / Code **HP-1502**  
En/W Boy/L Yük/H  
Dış / Ext 400 x 600 x 150 mm  
İç / Int 365 x 565 x 137 mm

Kod / Code **HP-2001**  
En/W Boy/L Yük/H  
Dış / Ext 400 x 600 x 200 mm  
İç / Int 365 x 565 x 188 mm

Kod / Code **HP-2002**  
En/W Boy/L Yük/H  
Dış / Ext 400 x 600 x 200 mm  
İç / Int 365 x 565 x 188 mm

Kod / Code **HP-2301**  
En/W Boy/L Yük/H  
Dış / Ext 400 x 600 x 230 mm  
İç / Int 365 x 565 x 218 mm

Kod / Code **HP-2302**  
En/W Boy/L Yük/H  
Dış / Ext 400 x 600 x 230 mm  
İç / Int 365 x 565 x 218 mm

Yükseltme teraslı  
Walls with terrace

Kod / Code **HP-2005**  
En/W Boy/L Yük/H  
Dış / Ext 400 x 600 x 200 mm  
İç / Int 365 x 565 x 188 mm

Kod / Code **HP-2006**  
En/W Boy/L Yük/H  
Dış / Ext 400 x 600 x 200 mm  
İç / Int 365 x 565 x 188 mm

Yükseltme teraslı  
Walls with terrace

Kod / Code **HP-2305**  
En/W Boy/L Yük/H  
Dış / Ext 400 x 600 x 230 mm  
İç / Int 365 x 565 x 218 mm

Kod / Code **HP-2306**  
En/W Boy/L Yük/H  
Dış / Ext 400 x 600 x 230 mm  
İç / Int 365 x 565 x 218 mm





Kod / Code **HP-3002**  
En/W Boy/L Yük/H  
Dış / Ext 400 x 600 x 300 mm  
İç / Int 365 x 565 x 284 mm



Kod / Code **HP-3402**  
En/W Boy/L Yük/H  
Dış / Ext 400 x 600 x 340 mm  
İç / Int 365 x 565 x 324 mm



Kod / Code **HP-3602**  
En/W Boy/L Yük/H  
Dış / Ext 400 x 600 x 360 mm  
İç / Int 365 x 565 x 342 mm



Kod / Code **HP-4002**  
En/W Boy/L Yük/H  
Dış / Ext 400 x 600 x 400 mm  
İç / Int 365 x 565 x 386 mm



Kod / Code **HP-4202**  
En/W Boy/L Yük/H  
Dış / Ext 400 x 600 x 425 mm  
İç / Int 365 x 565 x 410 mm



Kod / Code **HP-4502**  
En/W Boy/L Yük/H  
Dış / Ext 400 x 600 x 450 mm  
İç / Int 365 x 565 x 436 mm

#### 400 x 600 mm Kasalar

Delikli plastik kasalar Meyve, Sebze, Narenciye taşımacılığı, Gıda, Tarım, Market, Sanayi ve bir çok sektörde kullanılmaktadır. Farklı ebat, renk ve taban seçenekleri ile PPC'den üretilen delikli kasalar isteğe göre el tutma yeri açık veya kapalı olarak tercih edilebilirler.

#### 400 x 600 mm Crates

Perforated plastic crates are used in fruits, vegetables, citrus transportation and food, agriculture, market sectors and in many other industries. PPC perforated crates have different size, color, base, open hand grip, closed hand grip options.

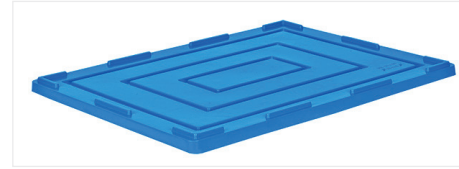

**HP-40x60** En/W Boy/L Yük/H  
Dış / Ext 400 x 600 x 20 mm  
Kapak / Lid



**HP-41x61** En/W Boy/L Yük/H  
Dış / Ext 400 x 600 x 10 mm  
Kapak / Lid



**Kod / Code** HP-3003  
**En/W Boy/L Yük/H**  
**Dış / Ext** 400 x 600 x 300 mm  
**İç / Int** 365 x 565 x 284 mm

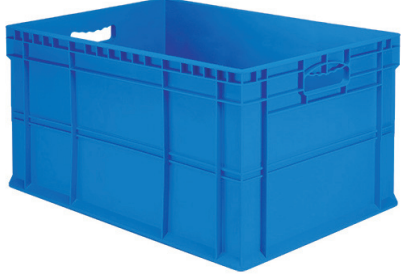

**Kod / Code** HP-3403  
**En/W Boy/L Yük/H**  
**Dış / Ext** 400 x 600 x 340 mm  
**İç / Int** 365 x 565 x 324 mm

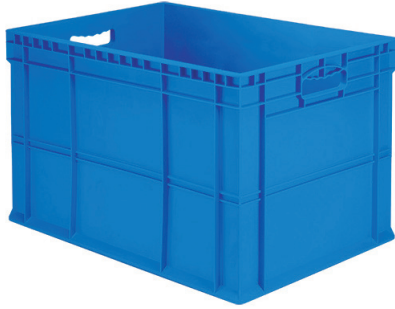

**Kod / Code** HP-3603  
**En/W Boy/L Yük/H**  
**Dış / Ext** 400 x 600 x 360 mm  
**İç / Int** 365 x 565 x 342 mm

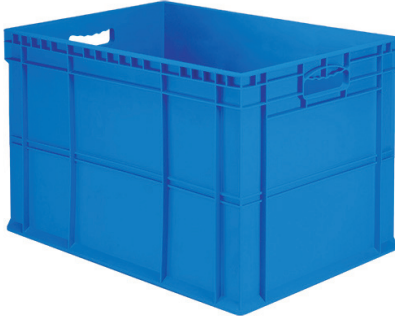

**Kod / Code** HP-4003  
**En/W Boy/L Yük/H**  
**Dış / Ext** 400 x 600 x 400 mm  
**İç / Int** 365 x 565 x 386 mm



**Kod / Code** HP-4203  
**En/W Boy/L Yük/H**  
**Dış / Ext** 400 x 600 x 425 mm  
**İç / Int** 365 x 565 x 410 mm

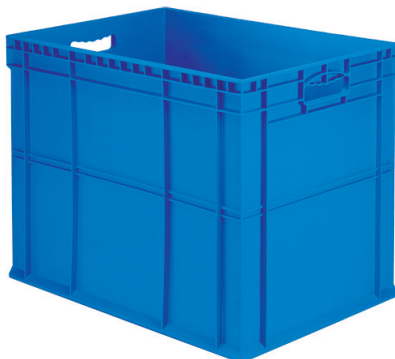

**Kod / Code** HP-4503  
**En/W Boy/L Yük/H**  
**Dış / Ext** 400 x 600 x 450 mm  
**İç / Int** 365 x 565 x 436 mm

#### HP-2003-1

**En/W Boy/L Yük/H**  
**Dış / Ext** 590 x 390 x 205 mm  
**İç / Int** 560 x 360 x 195 mm



#### 400 x 600 mm Kasalar

Kapalı kasalar sağlam yapısı sayesinde ürünlerinizi güvenle taşımanızı, depolamanızı ve istiflemenizi sağlar. Farklı ebat, renk ve taban seçenekleri ile PPC'den üretilen kapalı kasalar iste göre el tutma yeri açık veya kapalı olarak tercih edilebilirler.

#### 400 x 600 mm Crates

The solid crates allow you to carry and store your products safely with their robust structure. PPC solid crates have different size, color, base, open hand grip, closed hand grip options.

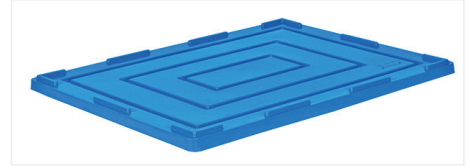

**HP-40x60** **En/W Boy/L Yük/H**  
**Dış / Ext** 400 x 600 x 20 mm  
**Kapak / Lid**

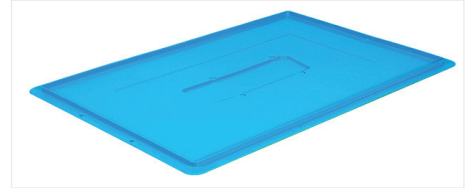

**HP-41x61** **En/W Boy/L Yük/H**  
**Dış / Ext** 400 x 600 x 10 mm  
**Kapak / Lid**

Önü Açık Kasalar  
Open Front Crates

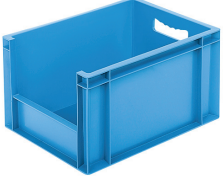

Kod / Code	<b>HP-4322 AV</b> <i>En/W Boy/L Yük/H</i>	<b>HP-4329 AV</b> <i>En/W Boy/L Yük/H</i>
Dış / Ext	295 x 395 x 230 mm	295 x 395 x 290 mm
İç / Int	263 x 265 x 215 mm	263 x 365 x 275 mm



Kod / Code	<b>HP-18 AV</b> <i>En/W Boy/L Yük/H</i>	<b>HP-27 AV</b> <i>En/W Boy/L Yük/H</i>
Dış / Ext	295 x 505 x 180 mm	295 x 505 x 235 mm
İç / Int	260 x 470 x 162 mm	260 x 470 x 217 mm

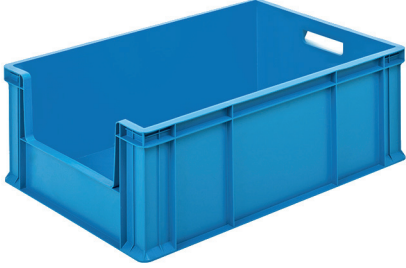

Kod / Code	<b>HP-4622 AV</b> <i>En/W Boy/L Yük/H</i>	<b>HP-4628 AV</b> <i>En/W Boy/L Yük/H</i>
Dış / Ext	400 x 600 x 220 mm	400 x 600 x 280 mm
İç / Int	365 x 565 x 205 mm	365 x 565 x 268 mm



Kod / Code	<b>HP-4642 AV</b> <i>En/W Boy/L Yük/H</i>	<b>HP-4634 AV</b> <i>En/W Boy/L Yük/H</i>
Dış / Ext	400 x 600 x 425 mm	400 x 600 x 340 mm
İç / Int	365 x 565 x 410 mm	365 x 565 x 325 mm



Kod / Code	<b>HP-4650 AV</b> <i>En/W Boy/L Yük/H</i>	<b>HP-4645 AV</b> <i>En/W Boy/L Yük/H</i>
Dış / Ext	400 x 600 x 500 mm	400 x 600 x 450 mm
İç / Int	365 x 565 x 485 mm	365 x 565 x 436 mm





Delikli Kasalar  
Perforated Crates



Kod / Code **E-24**  
En/W Boy/L Yük/H  
Dış / Ext 370 x 520 x 180 mm  
İç / Int 340 x 490 x 160 mm



Kod / Code **A-600-B**  
En/W Boy/L Yük/H  
Dış / Ext 365 x 525 x 315 mm  
İç / Int 340 x 500 x 310 mm



Kod / Code **B-550-K**  
En/W Boy/L Yük/H  
Dış / Ext 420 x 625 x 260 mm  
İç / Int 380 x 580 x 240 mm



Kod / Code **E-35**  
En/W Boy/L Yük/H  
Dış / Ext 375 x 520 x 195 mm  
İç / Int 340 x 490 x 180 mm



Kod / Code **E-100**  
En/W Boy/L Yük/H  
Dış / Ext 300 x 400 x 120 mm  
İç / Int 285 x 360 x 110 mm



Kod / Code **AX-850**  
En/W Boy/L Yük/H  
Dış / Ext 444 x 634 x 150 mm  
İç / Int 435 x 620 x 134 mm



Kod / Code **E-5421**  
En/W Boy/L Yük/H  
Dış / Ext 400 x 500 x 210 mm  
İç / Int 370 x 470 x 200 mm



Kod / Code **E-6430**  
En/W Boy/L Yük/H  
Dış / Ext 400 x 600 x 310 mm  
İç / Int 370 x 570 x 300 mm



Kod / Code **E-6440**  
En/W Boy/L Yük/H  
Dış / Ext 400 x 600 x 410 mm  
İç / Int 370 x 570 x 400 mm



Kod / Code **GK-910**  
En/W Boy/L Yük/H  
Dış / Ext 425 x 655 x 390 mm  
İç / Int 395 x 635 x 380 mm



400 X 600 mm Sanayi Kasaları  
400 X 600 mm Industrial Crates

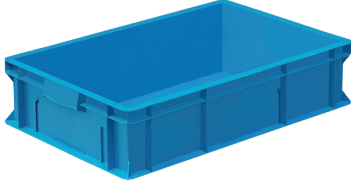

Kod / Code **HP-4615**  
En/W Boy/L Yük/H  
Dış / Ext 400 x 600 x 145 mm  
İç / Int 360 x 560 x 130 mm



Kod / Code **HP-4617**  
En/W Boy/L Yük/H  
Dış / Ext 400 x 600 x 170 mm  
İç / Int 360 x 560 x 155 mm



Kod / Code **HP-4622**  
En/W Boy/L Yük/H  
Dış / Ext 400 x 600 x 220 mm  
İç / Int 360 x 560 x 205 mm



Kod / Code **HP-4628**  
En/W Boy/L Yük/H  
Dış / Ext 400 x 600 x 280 mm  
İç / Int 360 x 560 x 265 mm



Kod / Code **HP-4632**  
En/W Boy/L Yük/H  
Dış / Ext 400 x 600 x 325 mm  
İç / Int 360 x 560 x 310 mm



Kod / Code **HP-4642**  
En/W Boy/L Yük/H  
Dış / Ext 400 x 600 x 425 mm  
İç / Int 360 x 560 x 410 mm



Kod / Code **HP-4650**  
En/W Boy/L Yük/H  
Dış / Ext 400 x 600 x 500 mm  
İç / Int 360 x 560 x 485 mm



Güçlendirilmiş taban  
Reinforced base

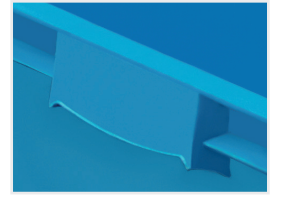

El korumalı tutamak  
Hand protected grip



Kanban Etiket Yuvası  
Kanban Label Slot



HP-100 / Kanban Etiket  
HP-100 / Kanban Label

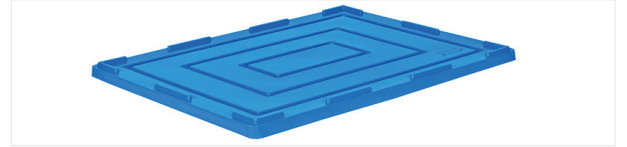

HP-40x60 En/W Boy/L Yük/H  
Dış / Ext 400 x 600 x 20 mm  
Kapak / Lid



Teker Takılabilir  
Optional wheels



**Aksesuarlar**  
Accessories



**HP-41x61** En/W Boy/L Yük/H  
Dış / Ext 400 x 600 x 10 mm  
400 X 600 mm Kapak / Lid



**AX-40x60** En/W Boy/L Yük/H  
Dış / Ext 400 x 600 x 20 mm  
400 X 600 mm Kapak / Lid

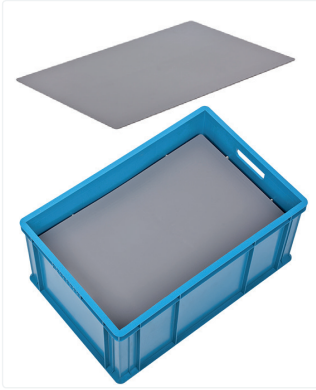

**HP-34x54** En/W Boy/L Yük/H  
Dış / Ext 340 x 540 x 10 mm  
Yatay Separatör  
Flat Separators



**T-50 50x75 mm**  
Tekerlek / Wheel  
HP-4615, HP-4617  
HP-4622, HP-4628



**T-75 75x105 mm**  
Tekerlek / Wheel  
HP-4632, HP-4642  
HP-4650, HP-6943-K



**Dolly 4060**  
Kod / Code En/W Boy/L Yük/H  
Dış / Ext 420 x 600 x 190 mm  
Plastik kasa taşıyıcı / Plastic dolly

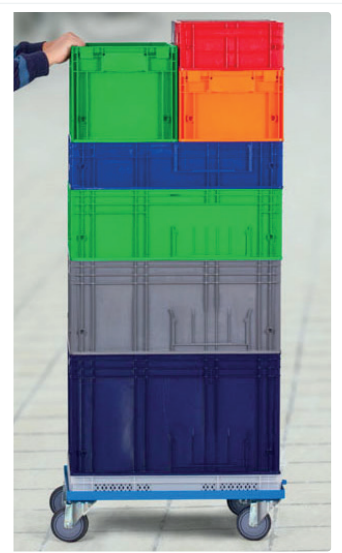

**YM-4060**  
Kod / Code En/W Boy/L Yük/H  
Dış / Ext 420 x 620 x 150 mm  
Metal Kasa Taşıyıcı  
Metal dolly



**Dolly 4161**  
Kod / Code En/W Boy/L Yük/H  
Dış / Ext 420 x 600 x 190 mm  
Plastik kasa taşıyıcı / Plastic dolly



**HP-100**  
Şeffaf Etiketlik  
Transparent label holder

**Uygulanabilir Kasalar :**  
Applicable Crates :

HP-4615, HP-4617, HP-4622, HP-4628,  
HP-4632, HP-4642, HP-4650



**Kanban Yapıştırma Etiketler**  
Sticker kanban label holders

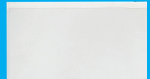

**KANBAN 225x160**  
225 X 160 mm



**KANBAN 225x90**  
225 X 90 mm



**KANBAN 150x90**  
150 X 90 mm

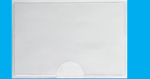

**KANBAN 110x110**  
110 X 110 mm



**Dikey Separatörler**  
Upright seperators

**SPR-26** 260X90 mm



**SPR-39** 356X90 mm



**SPR-59** 556X90 mm



**SPR-2618** 260X185 mm



**SPR-3618** 356X185 mm



**SPR-5618** 556X185 mm



**SPR-3615** 352X150 mm



**SPR-5615** 555X150 mm



400 X 600 mm Mentеше Kapaklı Kasalar  
400 X 600 mm Industrial Crates With Hinged Lids



Kod / Code **HP-4615 MK**  
En/W Boy/L Yük/H  
Dış / Ext 400 x 600 x 165 mm  
İç / Int 360 x 560 x 130 mm



Kod / Code **HP-4617 MK**  
En/W Boy/L Yük/H  
Dış / Ext 400 x 600 x 190 mm  
İç / Int 360 x 560 x 155 mm



Kod / Code **HP-4622 MK**  
En/W Boy/L Yük/H  
Dış / Ext 400 x 600 x 240 mm  
İç / Int 360 x 560 x 205 mm



Kod / Code **HP-4628 MK**  
En/W Boy/L Yük/H  
Dış / Ext 400 x 600 x 300 mm  
İç / Int 360 x 560 x 265 mm

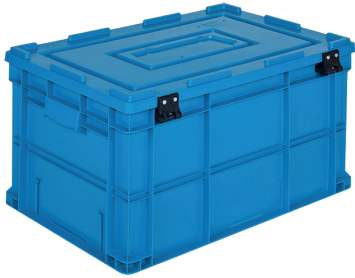

Kod / Code **HP-4632 MK**  
En/W Boy/L Yük/H  
Dış / Ext 400 x 600 x 345 mm  
İç / Int 360 x 560 x 310 mm



Kod / Code **HP-4642 MK**  
En/W Boy/L Yük/H  
Dış / Ext 400 x 600 x 445 mm  
İç / Int 360 x 560 x 410 mm



Kod / Code **HP-4650 MK**  
En/W Boy/L Yük/H  
Dış / Ext 400 x 600 x 520 mm  
İç / Int 360 x 560 x 485 mm



Güçlendirilmiş Taban  
Reinforced base

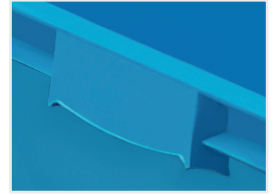

El korumalı tutamak  
Hand protected grip



Kanban Etiket Yuvası  
Kanban Label Slot



HP-100 / Kanban Etiket  
HP-100 / Kanban Label



Teker Takılabilir  
Optional wheels



480x690 mm Kasalar  
480x690 mm Crates



Kod / Code **HP-6943-A**  
En/W Boy/L Yük/H  
Dış / Ext 480 x 690 x 430 mm  
İç / Int 440 x 650 x 420 mm



Kod / Code **HP-6943-K**  
En/W Boy/L Yük/H  
Dış / Ext 480 x 690 x 430 mm  
İç / Int 440 x 650 x 420 mm



Kod / Code **HP-6943-AT**  
En/W Boy/L Yük/H  
Dış / Ext 480 x 690 x 540 mm  
İç / Int 440 x 650 x 420 mm



Kod / Code **HP-6943-KT**  
En/W Boy/L Yük/H  
Dış / Ext 480 x 690 x 540 mm  
İç / Int 440 x 650 x 420 mm



Kod / Code **HP-6943-MK**  
En/W Boy/L Yük/H  
Dış / Ext 480 x 690 x 455 mm  
İç / Int 440 x 650 x 420 mm



Kod / Code **HP-6943-MKT**  
En/W Boy/L Yük/H  
Dış / Ext 480 x 690 x 555 mm  
İç / Int 440 x 650 x 420 mm



Kod / Code **HP-6943-AV**  
En/W Boy/L Yük/H  
Dış / Ext 480 x 690 x 430 mm  
İç / Int 440 x 650 x 420 mm



Kod / Code **HP-43X69**  
En/W Boy/L Yük/H  
Dış / Ext 480 x 690 x 25 mm  
480 x 690 mm Kapak / Lid



Sanayi Kasaları  
Industrial Crates



Güçlendirilmiş Taban  
Reinforced Base



Düz Taban  
Flat Base



Kod / Code  
Dış / Ext  
İç / Int

**H-2111**  
En/W Boy/L Yük/H  
148 x 200 x 120 mm  
114 x 164 x 114 mm



Kod / Code  
Dış / Ext  
İç / Int

**H-3211 F**  
En/W Boy/L Yük/H  
200 x 300 x 120 mm  
162 x 262 x 103 mm

**H-3211 D**  
En/W Boy/L Yük/H  
200 x 300 x 120 mm  
162 x 262 x 115 mm



Kod / Code  
Dış / Ext  
İç / Int

**H-3220 F**  
En/W Boy/L Yük/H  
200 x 300 x 200 mm  
162 x 262 x 185 mm



Kod / Code  
Dış / Ext  
İç / Int

**H-3220 AV**  
En/W Boy/L Yük/H  
195 x 295 x 200 mm  
160 x 255 x 185 mm



**H-3220 BL**  
Kod / Code En/W Boy/L Yük/H  
Dış / Ext 158 x 75 x 3 mm  
Şeffaf Pencere  
transparent window

**HP-20x30 Kapak / Lid**  
En/W Boy/L Yük/H  
200 x 300 x 10 mm  
Kapak / Lid



**KN-1322**  
Kod / Code En/W Boy/L Yük/H  
Dış / Ext 296 x 996 x 213 mm  
İç / Int 262 x 962 x 211 mm

300x400 mm Kasalar  
300x400 mm Crates



Güçlendirilmiş Taban  
Reinforced Base

Düz Taban  
Flat Base



Kod / Code  
Dış / Ext  
İç / Int

**HP-4311 D**  
En/W Boy/L Yük/H  
295 x 395 x 117 mm  
263 x 365 x 112 mm



Kod / Code  
Dış / Ext  
İç / Int

**HP-4316 F**  
En/W Boy/L Yük/H  
295 x 395 x 174 mm  
263 x 365 x 160 mm

**HP-4316 D**  
En/W Boy/L Yük/H  
295 x 395 x 174 mm  
263 x 365 x 170 mm



Kod / Code  
Dış / Ext  
İç / Int

**HP-4322 F**  
En/W Boy/L Yük/H  
295 x 395 x 230 mm  
263 x 365 x 215 mm

**HP-4322 D**  
En/W Boy/L Yük/H  
295 x 395 x 230 mm  
263 x 365 x 225 mm

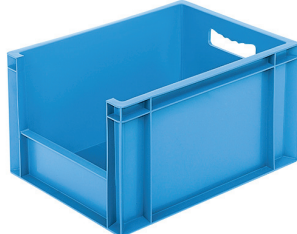

Kod / Code  
Dış / Ext  
İç / Int

**HP-4322 AV**  
En/W Boy/L Yük/H  
295 x 395 x 230 mm  
263 x 365 x 215 mm



Kod / Code  
Dış / Ext  
İç / Int

**HP-4329 F**  
En/W Boy/L Yük/H  
295 x 395 x 290 mm  
263 x 365 x 275 mm

**HP-4329 D**  
En/W Boy/L Yük/H  
295 x 395 x 290 mm  
263 x 365 x 285 mm



Kod / Code  
Dış / Ext  
İç / Int

**HP-4329 AV**  
En/W Boy/L Yük/H  
295 x 395 x 290 mm  
263 x 365 x 275 mm



**HP-30x40 Kapak / Lid**  
300 x 400 x 10 mm  
300 x 400 Kapak / Lid



**HP-31x41 Kapak / Lid**  
303 x 405 x 30 mm  
300 x 400 Kapak / Lid

Sanayi Kasaları  
Industrial Crates



Kod / Code **HP-160 K**  
En/W Boy/L Yük/H  
Dış / Ext 256 x 505 x 165 mm  
İç / Int 224 x 470 x 150 mm



Kod / Code **HP-260 K**  
En/W Boy/L Yük/H  
Dış / Ext 256 x 505 x 221 mm  
İç / Int 224 x 470 x 207 mm



Kod / Code **HP-18 K**  
En/W Boy/L Yük/H  
Dış / Ext 295 x 505 x 180 mm  
İç / Int 260 x 470 x 207 mm



Kod / Code **HP-18-AV**  
En/W Boy/L Yük/H  
Dış / Ext 295 x 505 x 180 mm  
İç / Int 260 x 470 x 162 mm

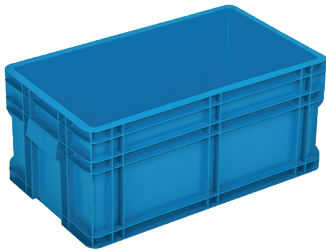

Kod / Code **HP-27-K**  
En/W Boy/L Yük/H  
Dış / Ext 295 x 505 x 235 mm  
İç / Int 260 x 470 x 217 mm

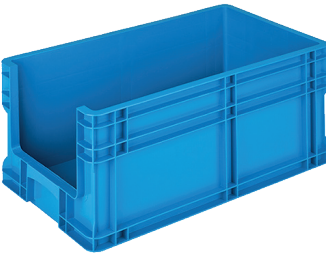

Kod / Code **HP-27-AV**  
En/W Boy/L Yük/H  
Dış / Ext 295 x 505 x 235 mm  
İç / Int 260 x 470 x 217 mm



Kod / Code **HP-270-K**  
En/W Boy/L Yük/H  
Dış / Ext 355 x 415 x 190 mm  
İç / Int 330 x 385 x 175 mm

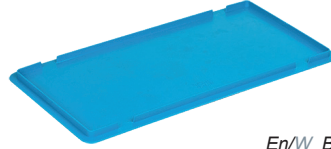

En/W Boy/L Yük/H  
**HP-26x50** 256 x 505 x 10 mm  
HP-160-K ve HP-260-K için kapak  
Lid for HP-160-K and HP-260-K

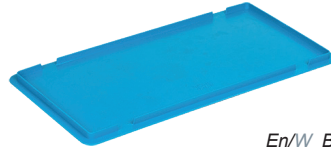

En/W Boy/L Yük/H  
**HP-30x50** 295 x 505 x 10 mm  
HP-18-K ve HP-27-K Uyumlu kapak  
Lid for HP-18-K and HK-27-K





**Katlanır Kapalı Kasalar**  
Folding Solid Crates

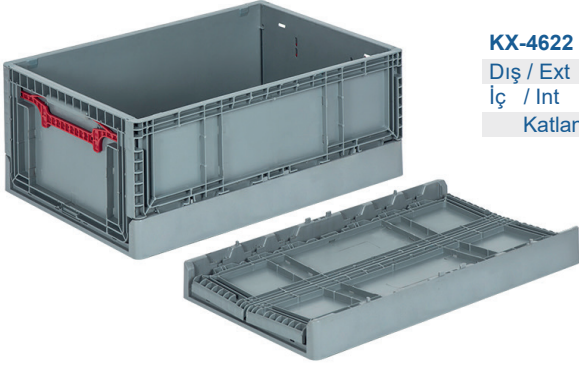

**KX-4622** En/W Boy/L Yük/H  
Dış / Ext 400 x 600 x 230 mm  
İç / Int 365 x 560 x 220 mm  
Katlanmış Yükseklik 73 mm  
Folded Height 73 mm

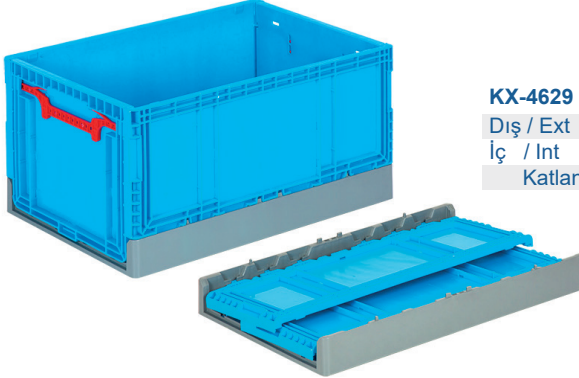

**KX-4629** En/W Boy/L Yük/H  
Dış / Ext 400 x 600 x 290 mm  
İç / Int 365 x 560 x 280 mm  
Katlanmış Yükseklik 73 mm  
Folded Height 73 mm

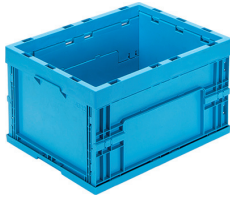

**KT-4322** En/W Boy/L Yük/H  
Dış / Ext 296 x 395 x 230 mm  
İç / Int 255 x 355 x 226 mm  
Katlanmış Yükseklik 65 mm  
Folded Height 65 mm



**KT-4633** En/W Boy/L Yük/H  
Dış / Ext 395 x 604 x 340 mm  
İç / Int 364 x 562 x 326 mm  
Katlanmış Yükseklik 80 mm  
Folded Height 80 mm



**KT-4822-F** En/W Boy/L Yük/H  
Dış / Ext 400 x 800 x 230 mm  
İç / Int 362 x 759 x 213 mm  
Katlanmış Yükseklik 53 mm  
Folded Height 53 mm



**KT-8634** En/W Boy/L Yük/H  
Dış / Ext 600 x 800 x 340 mm  
İç / Int 565 x 764 x 334 mm  
Katlanmış Yükseklik 80 mm  
Folded Height 80 mm

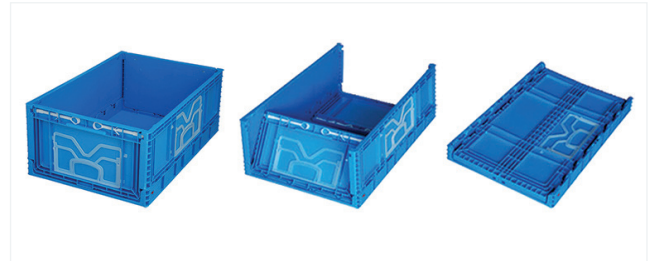
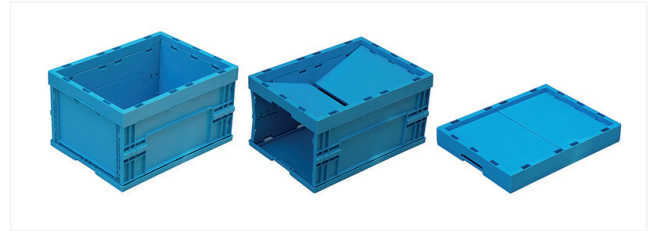
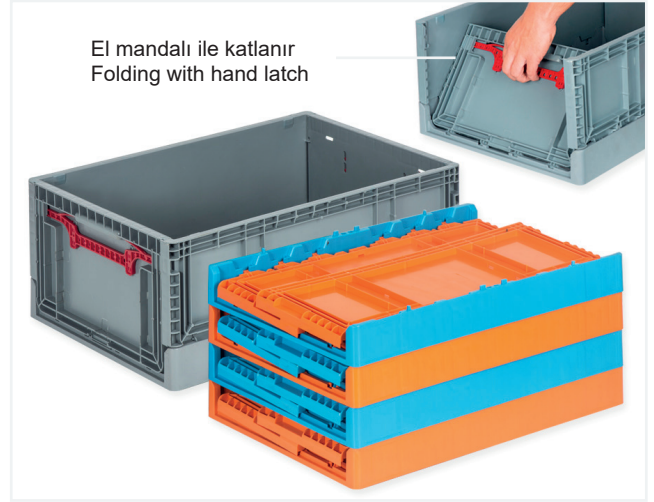

**Katlanır Delikli Kasalar**  
Folding Perforated Crates

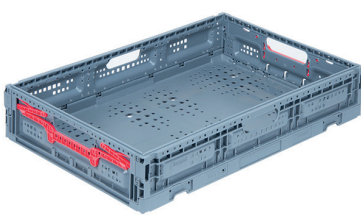

**PG-6411** En/W Boy/L Yük/H  
Dış / Ext 400 x 600 x 115 mm  
İç / Int 376 x 576 x 106 mm  
Katlanmış Yükseklik 30 mm  
Folded Height 30 mm

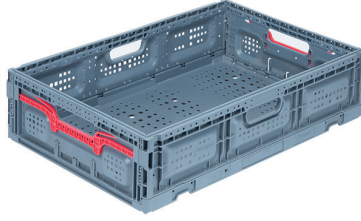

**PG-6415** En/W Boy/L Yük/H  
Dış / Ext 400 x 600 x 150 mm  
İç / Int 376 x 576 x 141 mm  
Katlanmış Yükseklik 30 mm  
Folded Height 30 mm

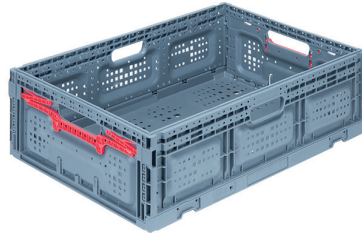

**PG-6418** En/W Boy/L Yük/H  
Dış / Ext 400 x 600 x 185 mm  
İç / Int 362 x 576 x 176 mm  
Katlanmış Yükseklik 30 mm  
Folded Height 30 mm

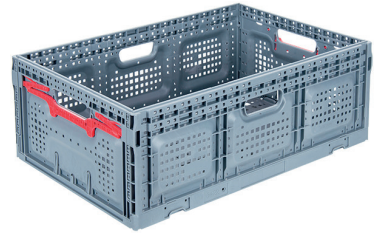

**PG-6422** En/W Boy/L Yük/H  
Dış / Ext 400 x 600 x 219 mm  
İç / Int 362 x 576 x 210 mm  
Katlanmış Yükseklik 30 mm  
Folded Height 30 mm

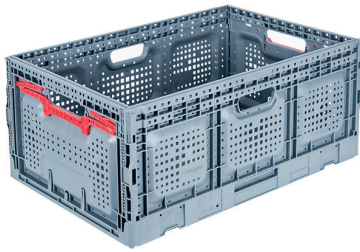

**PG-6426** En/W Boy/L Yük/H  
Dış / Ext 400 x 600 x 259 mm  
İç / Int 376 x 576 x 251 mm  
Katlanmış Yükseklik 47 mm  
Folded Height 47 mm

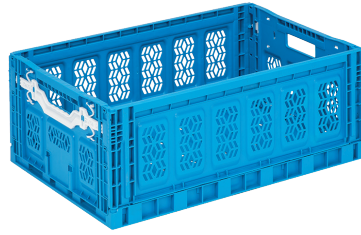

**KTA-6422** En/W Boy/L Yük/H  
Dış / Ext 400 x 600 x 225 mm  
İç / Int 372 x 572 x 215 mm  
Katlanmış Yükseklik 40 mm  
Folded Height 40 mm

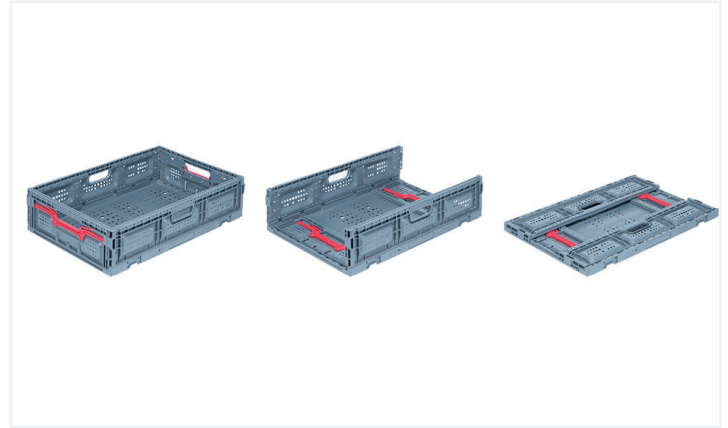

**KTA-4316** En/W Boy/L Yük/H  
Dış / Ext 400 x 300 x 158 mm  
İç / Int 372 x 573 x 150 mm  
Katlanmış Yükseklik 28 mm  
Folded Height 28 mm



**KT-6416** En/W Boy/L Yük/H  
Dış / Ext 400 x 600 x 157 mm  
İç / Int 372 x 573 x 153 mm  
Katlanmış Yükseklik 32 mm  
Folded Height 32 mm



**KT-6418** En/W Boy/L Yük/H  
Dış / Ext 400 x 600 x 177 mm  
İç / Int 372 x 573 x 173 mm  
Katlanmış Yükseklik 32 mm  
Folded Height 32 mm

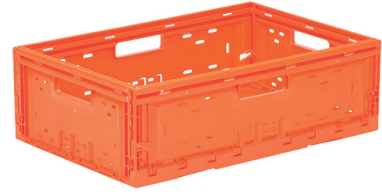

**KT-6420** En/W Boy/L Yük/H  
Dış / Ext 400 x 600 x 197 mm  
İç / Int 372 x 573 x 193 mm  
Katlanmış Yükseklik 32 mm  
Folded Height 32 mm



### Kapaklı Konik Kasalar

- Kapakları kapalıyken üstüste istiflenir ve taşınır.
- Kapakları açık iken içiçe geçerek yerden tasarruf sağlar.
- Konveyör sistemde kullanmaya uygundur.
- Eurobox standartlarına göre üretilmiştir.
- 4 Farklı yükseklikte olup üst üste istiflenebilmektedirler.
- Plastik kelepçe ve mühür uygulanabilirliği ile ürünlerinizin daha sağlıklı ve güvenilir taşınmasını sağlamaktadır.

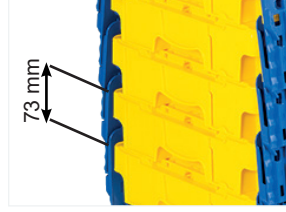

İç içe İstifleme Yükseklik  
Nesting height



### ALC Attached Lid Crates

- Can be stacked and transported on top of each other when the lids are closed.
- When the lids are open, the nested design allows to save from the volume.
- Suitable for conveyor systems.
- Can be stacked with 4 different heights.
- Plastic cable tie and seal can be applied that your products are transported safely

### 300 x 400 Kapaklı Konik Kasalar 300 x 400 ALC Attached Lid Crates

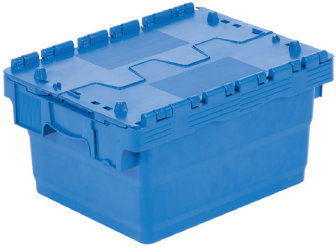

**HP-4321-MK** En/W Boy/L Yük/H  
Dış / Ext 300 x 400 x 210 mm  
İç / Int 265 x 340 x 190 mm

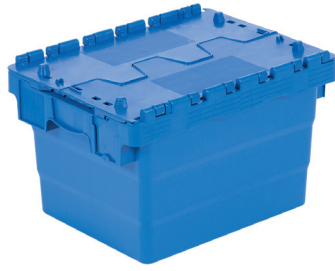

**HP-4325-MK** En/W Boy/L Yük/H  
Dış / Ext 300 x 400 x 250 mm  
İç / Int 265 x 340 x 230 mm



**HP-4332-MK** En/W Boy/L Yük/H  
Dış / Ext 300 x 400 x 320 mm  
İç / Int 265 x 340 x 300 mm



**HP-4336-MK** En/W Boy/L Yük/H  
Dış / Ext 300 x 400 x 365 mm  
İç / Int 265 x 340 x 345 mm

### 400 x 600 Kapaklı Konik Kasalar 400 x 600 ALC Attached Lid Crates

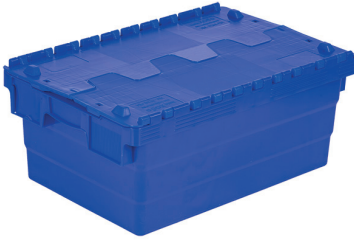

**HP-6425-MK** En/W Boy/L Yük/H  
Dış / Ext 400 x 600 x 250 mm  
İç / Int 365 x 543 x 232 mm

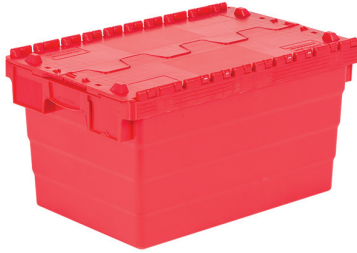

**HP-6432-MK** En/W Boy/L Yük/H  
Dış / Ext 400 x 600 x 320 mm  
İç / Int 365 x 545 x 302 mm



**HP-6435-MK** En/W Boy/L Yük/H  
Dış / Ext 400 x 600 x 360 mm  
İç / Int 365 x 545 x 347 mm



**HP-6440-MK** En/W Boy/L Yük/H  
Dış / Ext 400 x 600 x 415 mm  
İç / Int 365 x 545 x 398 mm



Tüm modellerimizde Pp levha seperatör uygulanabilir. PP sheet separators can be applied on all our designs .



Plastik Kelepçe Takılabilir.  
Plastic cable tie can be applied



İç içe İstifleme Yükseklik  
Nesting height

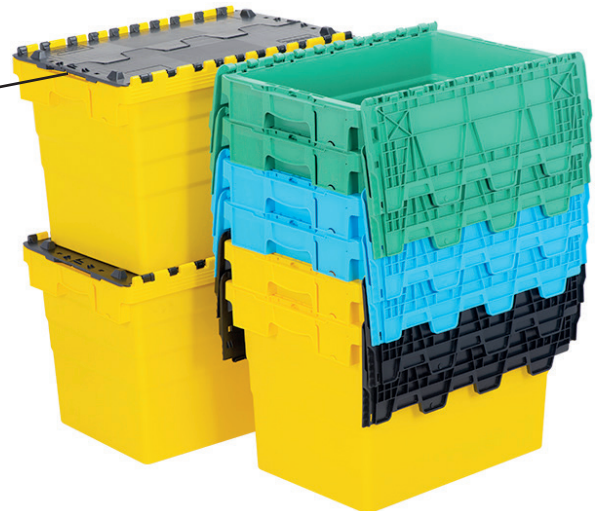

**Kapaklı Konik Kasalar**  
Nestable Crates



**HX-2311-MK** *En/W Boy/L Yük/H*  
Dış / Ext 225 x 295 x 125 mm  
İç / Int 200 x 270 x 108 mm



**HX-2316-MK** *En/W Boy/L Yük/H*  
Dış / Ext 225 x 295 x 175 mm  
İç / Int 200 x 270 x 158 mm



**HX-5316-MK** *En/W Boy/L Yük/H*  
Dış / Ext 300 x 490 x 175 mm  
İç / Int 257 x 430 x 155 mm



**HX-5322-MK** *En/W Boy/L Yük/H*  
Dış / Ext 300 x 490 x 235 mm  
İç / Int 257 x 430 x 210 mm

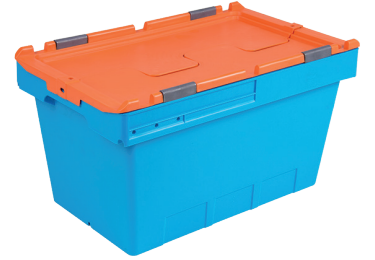

**HX-5326-MK** *En/W Boy/L Yük/H*  
Dış / Ext 300 x 490 x 275 mm  
İç / Int 257 x 430 x 255 mm



**HX-5311** *En/W Boy/L Yük/H*  
Dış / Ext 300 x 490 x 110 mm  
İç / Int 257 x 430 x 107 mm



**HX-5316** *En/W Boy/L Yük/H*  
Dış / Ext 300 x 490 x 160 mm  
İç / Int 257 x 430 x 155 mm



**HX-5322** *En/W Boy/L Yük/H*  
Dış / Ext 300 x 490 x 220 mm  
İç / Int 257 x 430 x 210 mm



**HX-5326** *En/W Boy/L Yük/H*  
Dış / Ext 300 x 490 x 260 mm  
İç / Int 257 x 430 x 255 mm



**HX-5300** *En/W Boy/L Yük/H*  
Dış / Ext 310 x 503 x 50 mm



**HX-2300** *En/W Boy/L Yük/H*  
Dış / Ext 230 x 302 x 15 mm



**HX-2311** *En/W Boy/L Yük/H*  
Dış / Ext 225 x 295 x 110 mm  
İç / Int 200 x 270 x 108 mm



**HX-2316** *En/W Boy/L Yük/H*  
Dış / Ext 225 x 295 x 160 mm  
İç / Int 200 x 270 x 158 mm

50 mm  
İç içe İstifleme  
Yükseklik  
Nesting height



**400 x 800 Kasalar**  
400 x 800 Crates



**Kod / Code** H-4811  
*En/W Boy/L Yük/H*  
**Dış / Ext** 400 x 800 x 119 mm  
**İç / Int** 356 x 758 x 109 mm

**400 x 1200 Kasalar**  
400 x 1200 Crates



**Kod / Code** H-4111  
*En/W Boy/L Yük/H*  
**Dış / Ext** 400 x 1200 x 119 mm  
**İç / Int** 358 x 1157 x 108 mm



**Kod / Code** H-4816  
*En/W Boy/L Yük/H*  
**Dış / Ext** 400 x 800 x 171 mm  
**İç / Int** 352 x 752 x 158 mm



**Kod / Code** H-4116  
*En/W Boy/L Yük/H*  
**Dış / Ext** 400 x 1200 x 171 mm  
**İç / Int** 354 x 1154 x 158 mm

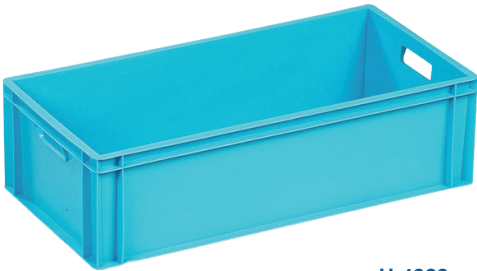

**Kod / Code** H-4822  
*En/W Boy/L Yük/H*  
**Dış / Ext** 400 x 800 x 227 mm  
**İç / Int** 352 x 752 x 215 mm



**Kod / Code** H-4122  
*En/W Boy/L Yük/H*  
**Dış / Ext** 400 x 1200 x 230 mm  
**İç / Int** 354 x 1154 x 215 mm



**Kod / Code** H-4828  
*En/W Boy/L Yük/H*  
**Dış / Ext** 400 x 800 x 278 mm  
**İç / Int** 348 x 748 x 265 mm



**Kod / Code** H-4133  
*En/W Boy/L Yük/H*  
**Dış / Ext** 400 x 1200 x 338 mm  
**İç / Int** 350 x 1154 x 324 mm



**Kod / Code** YM-4080  
*En/W Boy/L Yük/H*  
**Dış / Ext** 420 x 820 x 150 mm  
Metal Kasa Taşıyıcı / Metal dolly

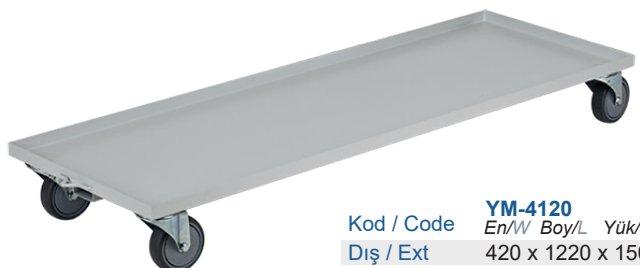

**Kod / Code** YM-4120  
*En/W Boy/L Yük/H*  
**Dış / Ext** 420 x 1220 x 150 mm  
Metal Kasa Taşıyıcı / Metal dolly

600x800 mm Kasalar  
600x800 mm Crates



Kod / Code **H-8611**  
En/W Boy/L Yük/H  
Dış / Ext 600 x 800 x 119 mm  
İç / Int 559 x 753 x 107 mm



Kod / Code **H-8616**  
En/W Boy/L Yük/H  
Dış / Ext 600 x 800 x 174 mm  
İç / Int 555 x 750 x 162 mm



Kod / Code **H-8622**  
En/W Boy/L Yük/H  
Dış / Ext 600 x 800 x 230 mm  
İç / Int 555 x 750 x 215 mm

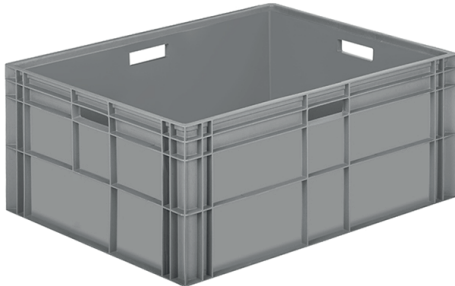

Kod / Code **H-8633**  
En/W Boy/L Yük/H  
Dış / Ext 600 x 800 x 340 mm  
İç / Int 555 x 750 x 325 mm



Kod / Code **H-8638**  
En/W Boy/L Yük/H  
Dış / Ext 600 x 800 x 388 mm  
İç / Int 555 x 748 x 374 mm

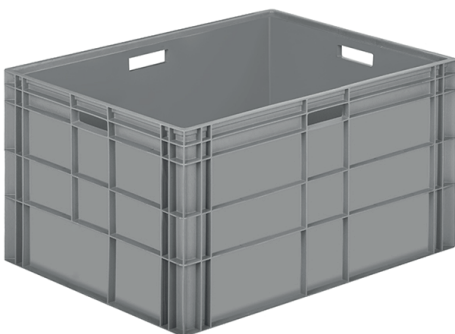

Kod / Code **H-8644**  
En/W Boy/L Yük/H  
Dış / Ext 600 x 800 x 450 mm  
İç / Int 552 x 747 x 435 mm



Kod / Code **HP-61X81**  
Dış / Ext 600 x 800 x 20 mm  
600X800 mm Kasalara uyumlu kapak  
Lid for 600X800 mm Crates



Kod / Code **H-8622-MK**  
En/W Boy/L Yük/H  
Dış / Ext 600 x 800 x 250 mm  
İç / Int 555 x 750 x 215 mm



Kod / Code **H-8633-MK**  
En/W Boy/L Yük/H  
Dış / Ext 600 x 800 x 360 mm  
İç / Int 555 x 750 x 325 mm



YM-60X80  
En/W Boy/L Yük/H  
Dış / Ext 620 x 820 x 160 mm  
600 X 800 Metal kasa taşıma arabası  
600 X 800 mm Metal dolly



Kod / Code **H-8644-MK**  
En/W Boy/L Yük/H  
Dış / Ext 600 x 800 x 450 mm  
İç / Int 555 x 750 x 435 mm

Plastik Konteynerler  
Plastic Containers



Kod / Code **GK-2100-K**  
En/W Boy/L Yük/H  
Dış / Ext 610 x 810 x 510 mm  
İç / Int 565 x 770 x 445 mm



Kod / Code **GK-2100-KT**  
En/W Boy/L Yük/H  
Dış / Ext 610 x 810 x 640 mm  
İç / Int 565 x 770 x 445 mm



Kod / Code **HP-61X81**  
En/W Boy/L Yük/H  
Dış / Ext 620 x 820 x 20 mm  
610X800 mm Kasalara uyumlu kapak  
Lid for 610X810 mm Crates

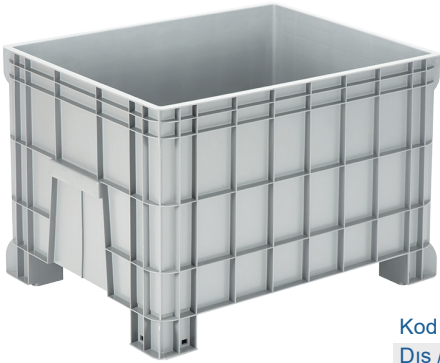

Kod / Code **K-330**  
En/W Boy/L Yük/H  
Dış / Ext 670 x 930 x 625 mm  
İç / Int 620 x 890 x 520 mm



Kod / Code **K-330-T**  
En/W Boy/L Yük/H  
Dış / Ext 670 x 930 x 770 mm  
İç / Int 620 x 890 x 520 mm



Kod / Code **K-310**  
En/W Boy/L Yük/H  
Dış / Ext 560 x 760 x 513 mm  
İç / Int 520 x 723 x 450 mm



Kod / Code **K-310-T**  
En/W Boy/L Yük/H  
Dış / Ext 560 x 760 x 663 mm  
İç / Int 520 x 723 x 450 mm



**Kapalı Konteynerler**  
Closed Containers



<b>K-370</b>	En/W	Boy/L	Yük/H	Hacim	Dynamic	Static
Dış / Ext	640 x	1000 x	550 mm	Volume	Capacity	Capacity
İç / Int	585 x	932 x	395 mm	200 Lt	300 Kg	1800 Kg
Kapalı / Closed	Ağırlık / Weight		10,50 kg			



<b>K-370 T</b>	En/W	Boy/L	Yük/H	Hacim	Dynamic	Static
Dış / Ext	640 x	1000 x	667 mm	Volume	Capacity	Capacity
İç / Int	585 x	932 x	395 mm	200 Lt	300 Kg	1800 Kg
Kapalı / Closed	Ağırlık / Weight		12,50 kg			

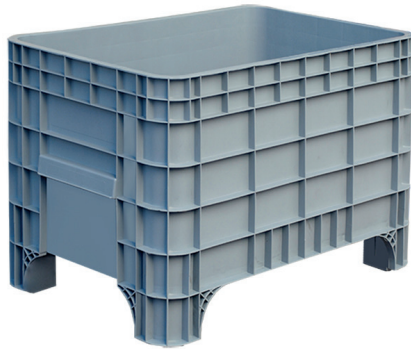

<b>K-400</b>	En/W	Boy/L	Yük/H	Hacim	Dynamic	Static
Dış / Ext	636 x	1017 x	673 mm	Volume	Capacity	Capacity
İç / Int	585 x	932 x	512 mm	270 Lt	300 Kg	1800 Kg
Kapalı / Closed	Ağırlık / Weight		12,00 kg			



<b>K-400 T</b>	En/W	Boy/L	Yük/H	Hacim	Dynamic	Static
Dış / Ext	636 x	1017 x	790 mm	Volume	Capacity	Capacity
İç / Int	585 x	932 x	512 mm	270 Lt	300 Kg	1800 Kg
Kapalı / Closed	Ağırlık / Weight		14,50 kg			

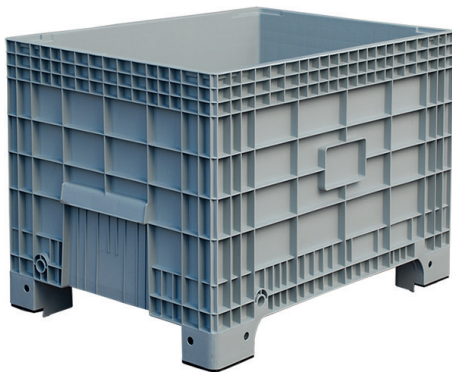

<b>K-550</b>	En/W	Boy/L	Yük/H	Hacim	Dynamic	Static
Dış / Ext	800 x	1200 x	800 mm	Volume	Capacity	Capacity
İç / Int	732 x	1106 x	617 mm	500 Lt	400 Kg	2500 Kg
Kapalı / Closed	Ağırlık / Weight		22,00 kg			

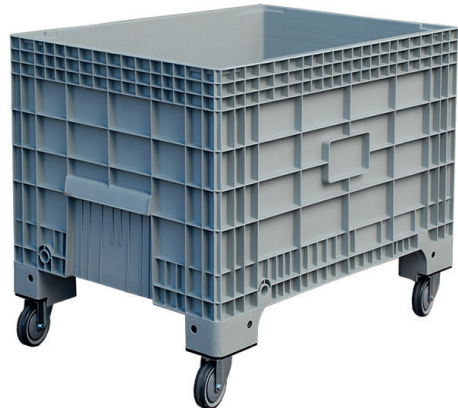

<b>K-550 T</b>	En/W	Boy/L	Yük/H	Hacim	Dynamic	Static
Dış / Ext	800 x	1200 x	925 mm	Volume	Capacity	Capacity
İç / Int	732 x	1108 x	617 mm	500 Lt	400 Kg	2500 Kg
Kapalı / Closed	Ağırlık / Weight		25,50 kg			



**HP-65x100** En/W Boy/L Yük/H  
Dış / Ext 650 x 1050 x 54 mm  
K-370 ve K-400 uyumlu kapak  
Lid for K-370 and K-400

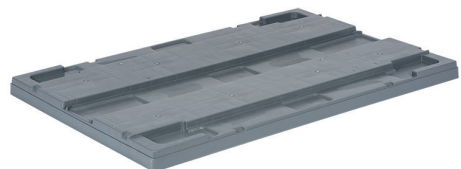

**HP-82x120** En/W Boy/L Yük/H  
Dış / Ext 805 x 1270 x 60 mm  
K-550 uyumlu kapak  
Lid for K-550

Delikli Konteynerler  
Perforated Containers

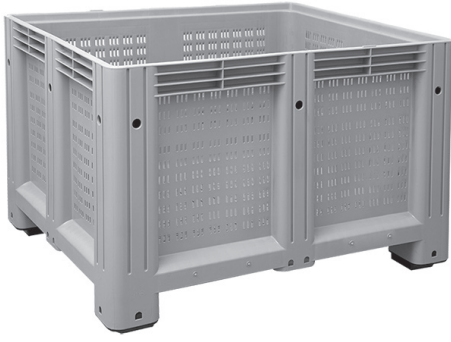

K-6500-A	En/W	Boy/L	Yük/H	Hacim	Dynamic	Static
Dış / Ext	1000	1200	580 mm	Volume	Capacity	Capacity
İç / Int	920	1120	430 mm	450 Lt	700 Kg	4000 Kg
Delikli / Perforated	Ağırlık / Weight		28,00 kg			



K-6500-AT	En/W	Boy/L	Yük/H	Hacim	Dynamic	Static
Dış / Ext	1000	1200	730 mm	Volume	Capacity	Capacity
İç / Int	920	1120	430 mm	450 Lt	700 Kg	4000 Kg
Delikli / Perforated	Ağırlık / Weight		33,00 kg			

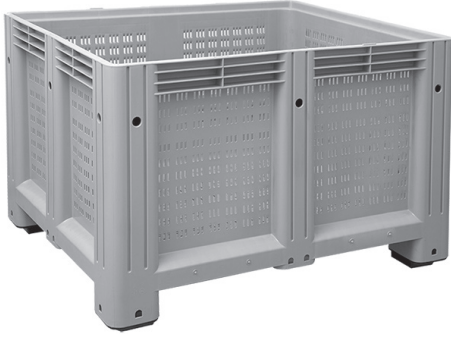

K-6600-A	En/W	Boy/L	Yük/H	Hacim	Dynamic	Static
Dış / Ext	1000	1200	760 mm	Volume	Capacity	Capacity
İç / Int	920	1120	610 mm	625 Lt	700 Kg	4000 Kg
Delikli / Perforated	Ağırlık / Weight		34,00 kg			



K-6600-AT	En/W	Boy/L	Yük/H	Hacim	Dynamic	Static
Dış / Ext	1000	1200	910 mm	Volume	Capacity	Capacity
İç / Int	920	1120	610 mm	625 Lt	700 Kg	4000 Kg
Delikli / Perforated	Ağırlık / Weight		39,00 kg			

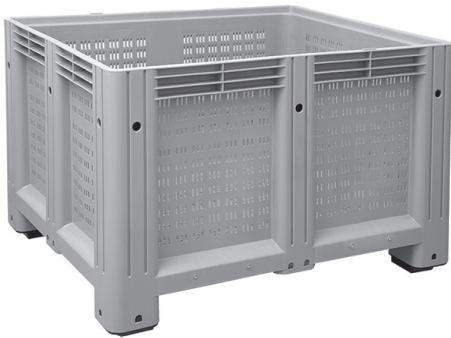

K-6700-A	En/W	Boy/L	Yük/H	Hacim	Dynamic	Static
Dış / Ext	1000	1200	850 mm	Volume	Capacity	Capacity
İç / Int	920	1120	700 mm	720 Lt	700 Kg	4000 Kg
Delikli / Perforated	Ağırlık / Weight		36,00 kg			



K-6700-AT	En/W	Boy/L	Yük/H	Hacim	Dynamic	Static
Dış / Ext	1000	1200	1000 mm	Volume	Capacity	Capacity
İç / Int	920	1120	700 mm	720 Lt	700 Kg	4000 Kg
Delikli / Perforated	Ağırlık / Weight		41,00 kg			



HP-102X120	En/W	Boy/L	Yük/H
Dış / Ext	1020	1200	60 mm
K-6500, K-6600 ve K-6700 Uyumlu Kapak Lid for K-6500, K-6600 and K-6700			

**Kapalı Konteynerler**  
Closed Containers



<b>K-6500-K</b>	En/W Boy/L Yük/H	Hacim	Dynamic	Static
Dış / Ext	1000 x 1200 x 580 mm	Volume	Capacity	Capacity
İç / Int	920 x 1120 x 430 mm	450 Lt	700 Kg	4000 Kg
Kapalı / Closed	Ağırlık / Weight	29,50 kg		



<b>K-6500-KT</b>	En/W Boy/L Yük/H	Hacim	Dynamic	Static
Dış / Ext	1000 x 1200 x 730 mm	Volume	Capacity	Capacity
İç / Int	920 x 1120 x 430 mm	450 Lt	700 Kg	4000 Kg
Kapalı / Closed	Ağırlık / Weight	34,00 kg		



<b>K-6600-K</b>	En/W Boy/L Yük/H	Hacim	Dynamic	Static
Dış / Ext	1000 x 1200 x 760 mm	Volume	Capacity	Capacity
İç / Int	920 x 1120 x 610 mm	450 Lt	700 Kg	4000 Kg
Kapalı / Closed	Ağırlık / Weight	36,00 kg		



<b>K-6600-KT</b>	En/W Boy/L Yük/H	Hacim	Dynamic	Static
Dış / Ext	1000 x 1200 x 910 mm	Volume	Capacity	Capacity
İç / Int	920 x 1120 x 610 mm	625 Lt	700 Kg	4000 Kg
Kapalı / Closed	Ağırlık / Weight	41,00 kg		



<b>K-6700-K</b>	En/W Boy/L Yük/H	Hacim	Dynamic	Static
Dış / Ext	1000 x 1200 x 850 mm	Volume	Capacity	Capacity
İç / Int	920 x 1120 x 700 mm	720 Lt	700 Kg	4000 Kg
Kapalı / Closed	Ağırlık / Weight	38,00 kg		



<b>K-6700-KT</b>	En/W Boy/L Yük/H	Hacim	Dynamic	Static
Dış / Ext	1000 x 1200 x 1000 mm	Volume	Capacity	Capacity
İç / Int	920 x 1120 x 700 mm	720 Lt	700 Kg	4000 Kg
Kapalı / Closed	Ağırlık / Weight	43,00 kg		



<b>HP-102X120</b>	En/W Boy/L Yük/H
Dış / Ext	1020 x 1200 x 60 mm
K-6500, K-6600 ve K-6700 Uyumlu Kapak Lid for K-6500, K-6600 and K-6700	

**Katlanır Konteynerler**  
Folding Containers



	En/W Boy/L Yük/H	Hacim	Dynamic	Static
Dış / Ext	1000 x 1200 x 800 mm	Volume	Capacity	Capacity
İç / Int	920 x 1120 x 650 mm	670 Lt	500 Kg	5000 Kg
Katlanmış Yükseklik / Folded Height		290 mm		
Delikli / Perforated	Ağırlık / Weight	41 kg+/- %3		



	En/W Boy/L Yük/H	Hacim	Dynamic	Static
Dış / Ext	1000 x 1200 x 800 mm	Volume	Capacity	Capacity
İç / Int	920 x 1120 x 650 mm	670 Lt	500 Kg	5000 Kg
Katlanmış Yükseklik / Folded Height		290 mm		
Kapalı / Closed	Ağırlık / Weight	42 kg+/- %3		

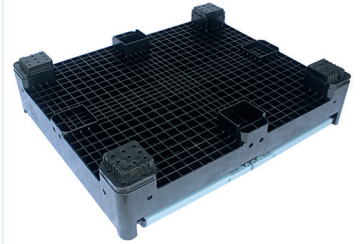

Standart 4 Ayak  
Standard 4 Feet



	En/W Boy/L Yük/H	Hacim	Dynamic	Static
Dış / Ext	1200 x 1200 x 800 mm	Volume	Capacity	Capacity
İç / Int	1120 x 1120 x 650 mm	820 Lt	500 Kg	5000 Kg
Katlanmış Yükseklik / Folded Height		290 mm		
Delikli / Perforated	Ağırlık / Weight	44 kg+/- %3		

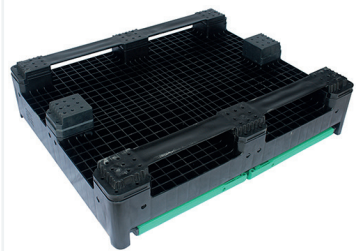

Aksesuar 2 Kızak  
Optional 2 Runners



	En/W Boy/L Yük/H	Hacim	Dynamic	Static
Dış / Ext	1200 x 1200 x 800 mm	Volume	Capacity	Capacity
İç / Int	1120 x 1120 x 650 mm	820 Lt	500 Kg	5000 Kg
Katlanmış Yükseklik / Folded Height		290 mm		
Kapalı / Closed	Ağırlık / Weight	45 kg+/- %3		

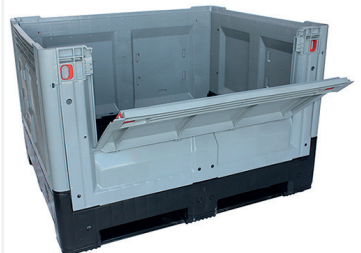

Aksesuar Flap Kapak  
Optional Flap

**Katlanır Konteynerler**  
Folding Containers

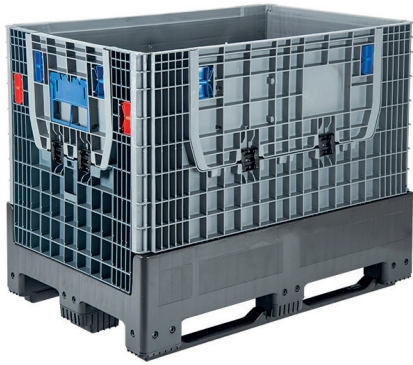

<b>KT-1208-80</b>	<i>En/W Boy/L Yük/H</i>
Dış / Ext	800 x 1200 x 800 mm
İç / Int	720 x 1120 x 630 mm
Katlanmış Yük. Folded Height	344 mm

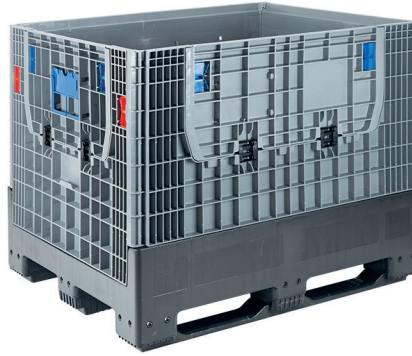

<b>KT-1210-80</b>	<i>En/W Boy/L Yük/H</i>
Dış / Ext	1000 x 1200 x 805 mm
İç / Int	920 x 1120 x 635 mm
Katlanmış Yük. Folded Height	349 mm

<b>KT-1208-95</b>	<i>En/W Boy/L Yük/H</i>
Dış / Ext	800 x 1200 x 950 mm
İç / Int	720 x 1120 x 780 mm
Katlanmış Yük. Folded Height	344 mm

<b>KT-1210-95</b>	<i>En/W Boy/L Yük/H</i>
Dış / Ext	1000 x 1200 x 975 mm
İç / Int	920 x 1120 x 805 mm
Katlanmış Yük. Folded Height	349 mm

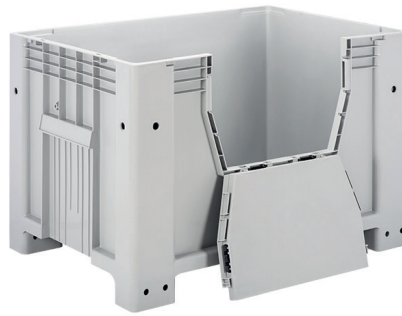
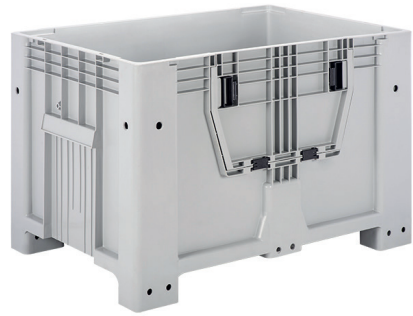
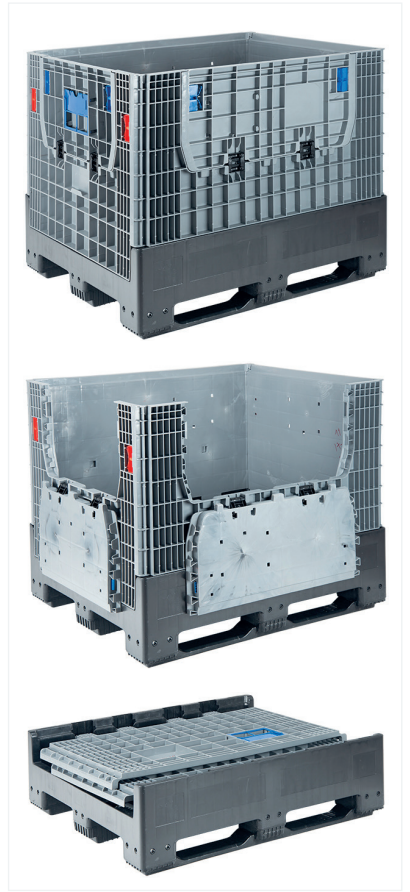

<b>K-570</b>	<i>En/W Boy/L Yük/H</i>	<i>Hacim</i>	<i>Dynamic</i>	<i>Static</i>
Dış / Ext	800 x 1200 x 800 mm	<i>Volume</i>	<i>Capacity</i>	<i>Capacity</i>
İç / Int	737 x 1013 x 632 mm	500 Lt	400 Kg	2500 Kg

<b>K-570-T</b>	<i>En/W Boy/L Yük/H</i>	<i>Hacim</i>	<i>Dynamic</i>	<i>Static</i>
Dış / Ext	800 x 1200 x 925 mm	<i>Volume</i>	<i>Capacity</i>	<i>Capacity</i>
İç / Int	737 x 1013 x 632 mm	500 Lt	400 Kg	2500 Kg



<b>AX-8633</b>	<i>En/W Boy/L Yük/H</i>
Dış / Ext	800 x 600 x 325 mm
İç / Int	695 x 490 x 295 mm

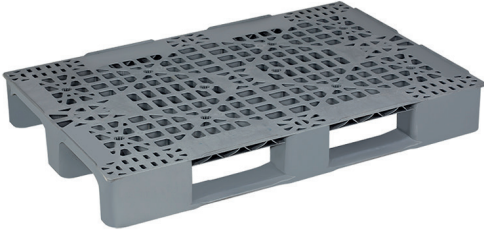

80-120 Üstü Delikli / Perforated	Static Capacity	Dynamic Capacity	Raf Capacity
En/W Boy/L Yük/H 800 x 1200 x 150 mm	3000 Kg	1000 Kg	600 Kg



80-120 K Üstü Kapalı / Closed	Static Capacity	Dynamic Capacity	Raf Capacity
En/W Boy/L Yük/H 800 x 1200 x 150 mm	3000 Kg	1000 Kg	600 Kg



100-120 Üstü Delikli / Perforated	Static Capacity	Dynamic Capacity	Raf Capacity
En/W Boy/L Yük/H 1000 x 1200 x 150 mm	3000 Kg	1000 Kg	600 Kg



100-120 K Üstü Kapalı / Closed	Static Capacity	Dynamic Capacity	Raf Capacity
En/W Boy/L Yük/H 1000 x 1200 x 150 mm	3000 Kg	1000 Kg	600 Kg

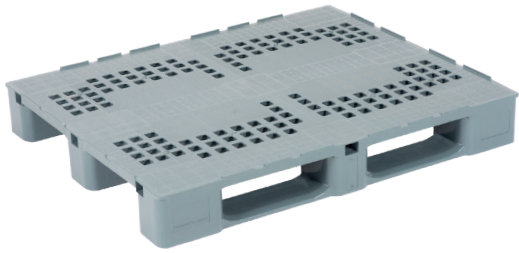

80-120 MW-P Profil Yuvalı / Profile Slot	Static Capacity	Dynamic Capacity	Raf Capacity
En/W Boy/L Yük/H 800 x 1200 x 150 mm	5000 Kg	1500 Kg	900 Kg
	Ağırlık / Weight	14.00 Kg	

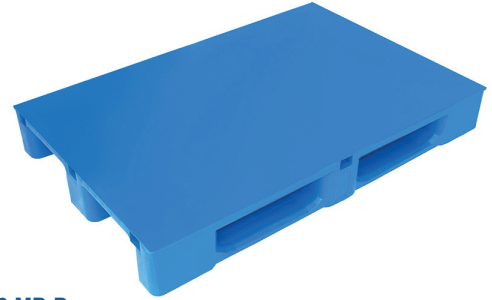

80-120 MP-P Profil Yuvalı / Profile Slot	Static Capacity	Dynamic Capacity	Raf Capacity
En/W Boy/L Yük/H 800 x 1200 x 150 mm	5000 Kg	1500 Kg	900 Kg
	Ağırlık / Weight	15.00 Kg	



60-80 Üstü Kapalı / Closed	Static Capacity	Raf Capacity
En/W Boy/L Yük/H 600 x 800 x 150 mm	2000 Kg	500 Kg



**100-120 MPP-P**  
**Profil Yuvalı / Profile Slot**

En/W Boy/L Yük/H	Static Capacity	Dynamic Capacity	Raf Capacity
1000 x 1200 x 155 mm	5000 Kg	1500 Kg	1000 Kg
	Ağırlık / Weight		18.00 Kg

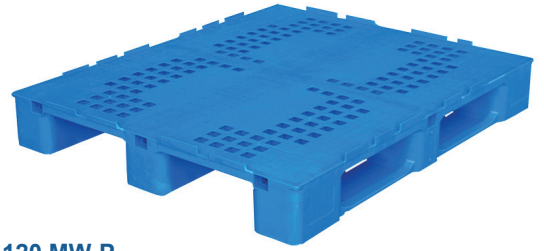

**100-120 MW-P**  
**Profil Yuvalı / Profile Slot**

En/W Boy/L Yük/H	Static Capacity	Dynamic Capacity	Raf Capacity
1000 x 1200 x 155 mm	5000 Kg	1500 Kg	1000 Kg
	Ağırlık / Weight		17.00 Kg



**100-120 MPP-5**  
**Profil Yuvalı / Profile Slot**

En/W Boy/L Yük/H	Static Capacity	Dynamic Capacity	Raf Capacity
1000 x 1200 x 155 mm	5000 Kg	1500 Kg	1000 Kg
	Ağırlık / Weight		18,50 Kg

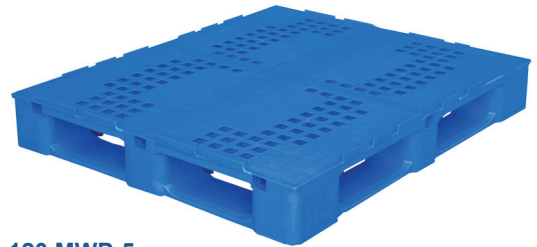

**100-120 MWP-5**  
**Profil Yuvalı / Profile Slot**

En/W Boy/L Yük/H	Static Capacity	Dynamic Capacity	Raf Capacity
1000 x 1200 x 155 mm	5000 Kg	1500 Kg	1000 Kg
	Ağırlık / Weight		18,50 Kg

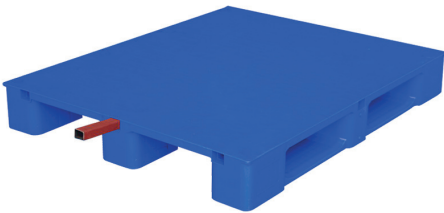

**1 Metal Profil Kapasitesi**  
**1 Metal Profile Capacity**

Dinamik / Dynamic	1750 Kg
Raf / Rack	1250 Kg

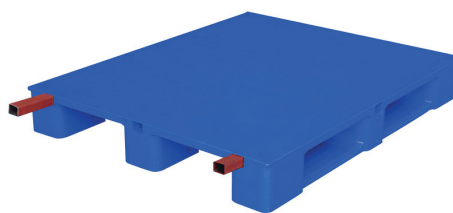

**2 Metal Profil Kapasitesi**  
**2 Metal Profile Capacity**

Dinamik / Dynamic	2000 Kg
Raf / Rack	1500 Kg

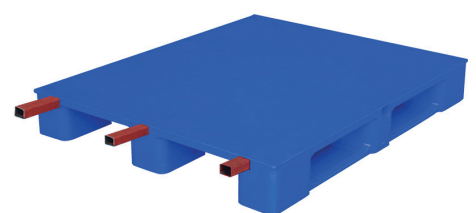

**3 Metal Profil Kapasitesi**  
**3 Metal Profile Capacity**

Dinamik / Dynamic	2250 Kg
Raf / Rack	1800 Kg

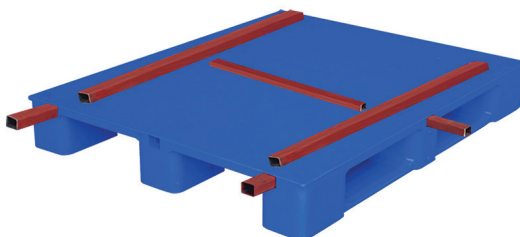

**H Metal Profil**  
**H Metal Profile**

Dinamik / Dynamic	2000 Kg
Raf / Rack	1500 Kg

80-120 MWP, 80-120 MPP, 100-120 MWP  
100-120 MPP, 100-120 MWP-5, 100-120-5



2 Kızak / 2 Kunner

3 Kızak / 3 Kunner

Raf Kapasite / Rack Capacity 250 Kg Raf Kapasite / Rack Capacity 400 Kg



80-120 XE	Static Capacity	Dynamic Capacity	Ağırlık Weight
En/W Boy/L Yük/H 800 x 1200 x 130 mm	1500 Kg	400 Kg	4,00 Kg

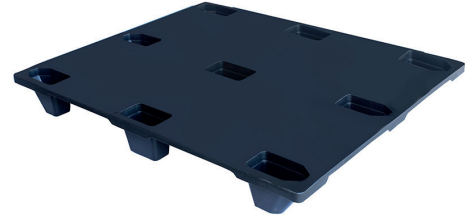

80-120 XEP	Static Capacity	Dynamic Capacity	Ağırlık Weight
En/W Boy/L Yük/H 800 x 1200 x 130 mm	1500 Kg	400 Kg	5,20 Kg



100-120 XE	Static Capacity	Dynamic Capacity	Ağırlık Weight
En/W Boy/L Yük/H 1000 x 1200 x 130 mm	1500 Kg	400 Kg	4,70 Kg

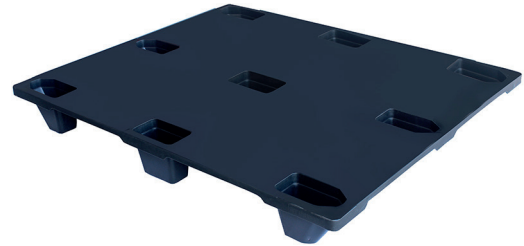

100-120 XEP	Static Capacity	Dynamic Capacity	Ağırlık Weight
En/W Boy/L Yük/H 1000 x 1200 x 130 mm	1500 Kg	400 Kg	6,20 Kg



80-120 EKO	Static Capacity	Dynamic Capacity	Ağırlık Weight
En/W Boy/L Yük/H 800 x 1200 x 134 mm	2000 Kg	1000 Kg	7,80 Kg



100-120 EKO	Static Capacity	Dynamic Capacity	Ağırlık Weight
En/W Boy/L Yük/H 1000 x 1200 x 134 mm	2000 Kg	1000 Kg	10,00 Kg



60-80 A	Static Capacity	Dynamic Capacity	Ağırlık Weight
En/W Boy/L Yük/H 600 x 800 x 134 mm	1000 Kg	500 Kg	2,50 Kg





Takoz uyumlu  
Wedge compatible



**80-120 MR**

**Profil Yapılı / Profile Structure**

En/W Boy/L Yük/H

800 x 1200 x 150 mm

Static  
Capacity

5000 Kg

Dynamic  
Capacity

1500 Kg

Raf  
Capacity

900 Kg

Ağırlık / Weight

15.00 Kg

**TKZ-39** En/W Boy/L Yük/H

39 x 390 x 70 mm

80-120-MR Uyumlu Takoz / Wedges



**80-120 Metal**

**Metal Palet / Metal Pallet**

En/W Boy/L Yük/H

800 x 1200 x 145 mm

Static  
Capacity

5000 Kg

Dynamic  
Capacity

1500 Kg

Pullu yüzey  
Scaly surface



**80-120 MP**

**Pullu Yüzeyle Palet**

**Scaly surface Pallet**

En/W Boy/L Yük/H

800 x 1200 x 150 mm

Static  
Capacity

5000 Kg

Dynamic  
Capacity

1500 Kg

Raf  
Capacity

900 Kg

Ağırlık / Weight

15.00 Kg



**HP-83X120**

En/W Boy/L Yük/H

805 x 1270 x 55 mm

80-120 Palete uyumlu kapak

Lid for 80-120 Pallet



**HP-103X120**

En/W Boy/L Yük/H

1050 x 1200 x 65 mm

100-120 Palete uyumlu kapak

Lid for 100-120 Pallet



Kimyasal madde boşaltma musluğu  
Chemical Discharging nozzle

**VMP-80X120**

En/W Boy/L Yük/H

800 x 1200 x 355 mm

Metal kimyasal varil paleti

Metal body, chemical barrel pallet



**VPP-80X120**

En/W Boy/L Yük/H

800 x 1200 x 355 mm

Gövde metal içi plastik varil paleti

Metal body, plastic barrel pallet



ESD R-KLT & RL-KLT Kasalar  
ESD R-KLT & RL-KLT Crates



Güçlendirilmiş Taban  
Reinforced Base



Düz Taban  
Flat Base



Kod / Code **R-KLT-3115**  
En/W Boy/L Yük/H  
Dış / Ext 200 x 300 x 147 mm  
İç / Int 170 x 245 x 125 mm

Kod / Code **RL-KLT-3115**  
En/W Boy/L Yük/H  
Dış / Ext 200 x 300 x 147 mm  
İç / Int 170 x 245 x 143 mm



Kod / Code **R-KLT-4115**  
En/W Boy/L Yük/H  
Dış / Ext 300 x 400 x 147 mm  
İç / Int 265 x 340 x 120 mm

Kod / Code **RL-KLT-4047**  
En/W Boy/L Yük/H  
Dış / Ext 300 x 400 x 147 mm  
İç / Int 265 x 340 x 143 mm



Kod / Code **R-KLT-4122**  
En/W Boy/L Yük/H  
Dış / Ext 300 x 400 x 215 mm  
İç / Int 265 x 340 x 195 mm

Kod / Code **RL-KLT-4013**  
En/W Boy/L Yük/H  
Dış / Ext 300 x 400 x 215 mm  
İç / Int 265 x 340 x 211 mm



Kod / Code **R-KLT-4129**  
En/W Boy/L Yük/H  
Dış / Ext 300 x 400 x 280 mm  
İç / Int 265 x 340 x 255 mm

Kod / Code **RL-KLT-4080**  
En/W Boy/L Yük/H  
Dış / Ext 300 x 400 x 280 mm  
İç / Int 265 x 340 x 276 mm



Kod / Code **R-KLT-6115**  
En/W Boy/L Yük/H  
Dış / Ext 400 x 600 x 147 mm  
İç / Int 364 x 544 x 109 mm

Kod / Code **RL-KLT-6047**  
En/W Boy/L Yük/H  
Dış / Ext 400 x 600 x 147 mm  
İç / Int 364 x 544 x 143 mm



Kod / Code **R-KLT-6122**  
En/W Boy/L Yük/H  
Dış / Ext 400 x 600 x 215 mm  
İç / Int 364 x 544 x 195 mm

Kod / Code **RL-KLT-6013**  
En/W Boy/L Yük/H  
Dış / Ext 400 x 600 x 215 mm  
İç / Int 364 x 544 x 211 mm



Kod / Code **R-KLT-6129**  
En/W Boy/L Yük/H  
Dış / Ext 400 x 600 x 280 mm  
İç / Int 364 x 544 x 255 mm

Kod / Code **RL-KLT-6080**  
En/W Boy/L Yük/H  
Dış / Ext 400 x 600 x 280 mm  
İç / Int 364 x 544 x 276 mm



ESD Kasalar  
ESD crates



**HP-4632 ESD** *En/W Boy/L Yük/H*  
Dış / Ext 400 x 600 x 325 mm  
İç / Int 360 x 560 x 310 mm



**HP-4628 ESD** *En/W Boy/L Yük/H*  
Dış / Ext 400 x 600 x 280 mm  
İç / Int 360 x 560 x 265 mm



**HP-4622 ESD** *En/W Boy/L Yük/H*  
Dış / Ext 400 x 600 x 220 mm  
İç / Int 360 x 560 x 205 mm



**HP-4617 ESD** *En/W Boy/L Yük/H*  
Dış / Ext 400 x 600 x 170 mm  
İç / Int 360 x 560 x 155 mm



**HP-4615 ESD** *En/W Boy/L Yük/H*  
Dış / Ext 400 x 600 x 145 mm  
İç / Int 360 x 560 x 130 mm

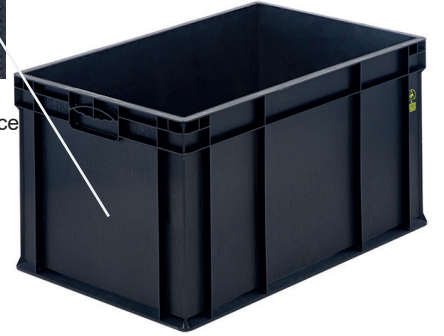

**HP-4633 ESD** *En/W Boy/L Yük/H*  
Dış / Ext 400 x 600 x 340 mm  
İç / Int 360 x 560 x 324 mm



**HP-40X60 ESD** *En/W Boy/L Yük/H*  
Dış / Ext 420 x 600 x 20 mm  
400 X 600 mm Kapak / Lid



**HP-41X61 ESD** *En/W Boy/L Yük/H*  
Dış / Ext 400 x 600 x 10 mm  
400 X 600 mm Kapak / Lid



**AX-40X60 ESD** *En/W Boy/L Yük/H*  
Dış / Ext 400 x 600 x 20 mm  
400 X 600 mm Kapak / Lid

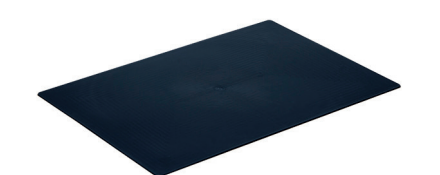

**SPR-34X54 ESD** *En/W Boy/L Yük/H*  
Dış / Ext 340 x 540 x 10 mm  
Yatay seperatör / Horizontal Separates



**SPR-5618 ESD**  
556 x 185 mm

**SPR-3618 ESD**  
356 x 185 mm

**SPR-5615 ESD**  
555 x 150 mm

**SPR-3615 ESD**  
352 x 150 mm

**SPR-59 ESD**  
556 x 90 mm

**SPR-39 ESD**  
356 x 90 mm

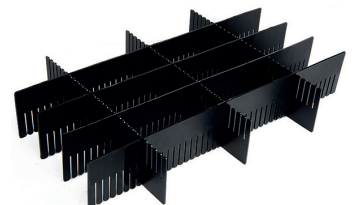



# ESD ANTİSTATİK ÜRÜNLER

## ESD CONDUCTIVE PRODUCTS



**HP-4329 ESD** En/W Boy/L Yüksek/H  
Dış / Ext 395 x 295 x 290 mm  
İç / Int 365 x 263 x 275 mm



**HP-4322 ESD** En/W Boy/L Yüksek/H  
Dış / Ext 395 x 295 x 230 mm  
İç / Int 365 x 263 x 215 mm



**HP-4316 ESD** En/W Boy/L Yüksek/H  
Dış / Ext 295 x 395 x 174 mm  
İç / Int 263 x 365 x 160 mm



**HP-4311 ESD** En/W Boy/L Yüksek/H  
Dış / Ext 295 x 395 x 117 mm  
İç / Int 263 x 365 x 112 mm



**H-3211 ESD** En/W Boy/L Yüksek/H  
Dış / Ext 200 x 300 x 120 mm  
İç / Int 162 x 262 x 115 mm



**HP-20X30 ESD** En/W Boy/L Yüksek/H  
Dış / Ext 200 x 300 x 10 mm  
200 X 300 mm Kapak / Lid



**HP-27-K ESD** En/W Boy/L Yüksek/H  
Dış / Ext 295 x 505 x 235 mm  
İç / Int 260 x 470 x 217 mm



**HP-31X41 ESD** En/W Boy/L Yüksek/H  
Dış / Ext 303 x 405 x 30 mm  
300 X 400 mm Kapak / Lid



**HP-6425-MK ESD** En/W Boy/L Yüksek/H  
Dış / Ext 400 x 600 x 250 mm  
İç / Int 365 x 543 x 232 mm



**HP-6432-MK ESD** En/W Boy/L Yüksek/H  
Dış / Ext 400 x 600 x 320 mm  
İç / Int 365 x 545 x 302 mm



**HP-6435-MK ESD** En/W Boy/L Yüksek/H  
Dış / Ext 400 x 600 x 360 mm  
İç / Int 365 x 545 x 347 mm



**HP-6440-MK ESD** En/W Boy/L Yüksek/H  
Dış / Ext 400 x 600 x 415 mm  
İç / Int 365 x 545 x 398 mm

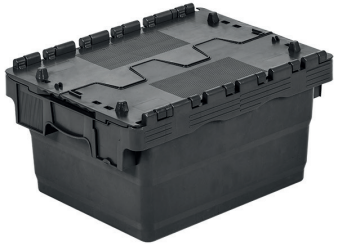

**HP-4321-ESD** En/W Boy/L Yüksek/H  
Dış / Ext 300 x 400 x 210 mm  
İç / Int 265 x 340 x 190 mm

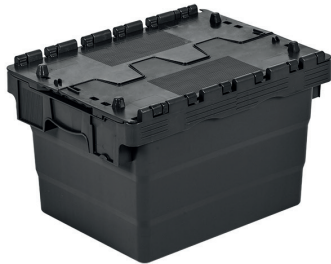

**HP-4325-ESD** En/W Boy/L Yüksek/H  
Dış / Ext 300 x 400 x 250 mm  
İç / Int 265 x 340 x 230 mm



**HP-4332-ESD** En/W Boy/L Yüksek/H  
Dış / Ext 300 x 400 x 320 mm  
İç / Int 265 x 340 x 300 mm



**HP-4336-ESD** En/W Boy/L Yüksek/H  
Dış / Ext 300 x 400 x 365 mm  
İç / Int 265 x 340 x 345 mm



**80-120 K ESD** En/W Boy/L Yüksek/H  
Dış / Ext 800 x 1200 x 150 mm

Static Capacity	Dynamic Capacity	Raf Capacity
3000 Kg	1000 Kg	600 Kg



Plastik Kelepçe Takılabilir.  
Plastic cable tie can be applied

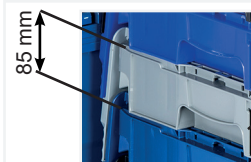

İççe İstifleme Yükseklik  
Nesting height

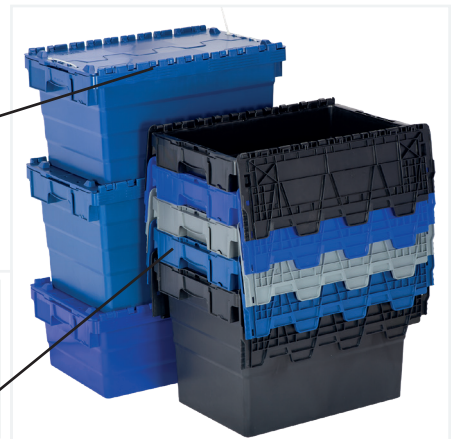



## ESD Plastik Avadanlık Kutular ESD Plastic Stacking Bins



**A-400 ESD** *En/W Boy/L Yük/H*  
Dış / Ext 310 x 490 x 190 mm



**A-350 ESD** *En/W Boy/L Yük/H*  
Dış / Ext 260 x 420 x 170 mm



**A-300-ESD** *En/W Boy/L Yük/H*  
Dış / Ext 215 x 355 x 152 mm



**A-250-ESD** *En/W Boy/L Yük/H*  
Dış / Ext 172 x 305 x 130 mm



**A-200-ESD** *En/W Boy/L Yük/H*  
Dış / Ext 150 x 240 x 122 mm



**A-150-ESD** *En/W Boy/L Yük/H*  
Dış / Ext 125 x 190 x 98 mm

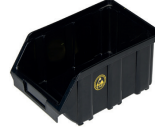

**A-100-ESD** *En/W Boy/L Yük/H*  
Dış / Ext 102 x 170 x 74 mm



**SV-419** *En/W Boy/L Yük/H*  
Dış / Ext 188 x 400 x 80 mm

## ESD Çekmeceli Kutular ESD Plastic Drawer Boxes



**510 ESD** *En/W Boy/L Yük/H*  
Dış / Ext 260 x 340 x 150 mm  
İç / Int 245 x 331 x 137 mm



**501 ESD** *En/W Boy/L Yük/H*  
Dış / Ext 212 x 306 x 126 mm  
İç / Int 197 x 297 x 112 mm



**500 ESD** *En/W Boy/L Yük/H*  
Dış / Ext 140 x 230 x 98 mm  
İç / Int 125 x 221 x 85 mm



**401 ESD** *En/W Boy/L Yük/H*  
Dış / Ext 120 x 200 x 80 mm  
İç / Int 110 x 197 x 70 mm



**351 ESD** *En/W Boy/L Yük/H*  
Dış / Ext 110 x 170 x 65 mm  
İç / Int 96 x 160 x 55 mm



**302 ESD** *En/W Boy/L Yük/H*  
Dış / Ext 106 x 122 x 62 mm  
İç / Int 102 x 118 x 59 mm



**305 ESD** *En/W Boy/L Yük/H*  
Dış / Ext 106 x 122 x 62 mm  
İç / Int 42 x 118 x 24 mm



**102 ESD** *En/W Boy/L Yük/H*  
Dış / Ext 85 x 120 x 40 mm  
İç / Int 75 x 115 x 35 mm



**HP-16 ESD** *En/W Boy/L Yük/H*  
Dış / Ext 97 x 48 x 48 mm



## ÇK-400

Çöp Kovası

Waste Bins En/W Boy/L Yük/H

Dış / Ext. 480 x 530 x 990 mm

Hacim / Volume 120 Lt.

Sticker Etiketli Çöp Konteynerleri  
Sticker Labeled Waste Containers



ÇK-400 CAM ATIK



ÇK-400 KAĞIT ATIK



ÇK-400 TIBBİ ATIK



ÇK-400 METAL ATIK



ÇK-400 PLASTİK ATIK



ÇK-400 TEHLİKELİ ATIK



ÇK-400 GK

ÇK-400 GS

ÇK-400 GM

ÇK-400 GT

ÇK-400 GY

Gri gövde üzerine farklı renkli kapaklar uygulanabilir.  
Different colored lids can be applied on grey body.



25 Lt.

**ÇK-20** En/W Boy/L Yük/H  
Dış / Ext 310 x 350 x 440 mm



40 Lt.

**ÇK-30** En/W Boy/L Yük/H  
Dış / Ext 360 x 390 x 440 mm



65 Lt.

**ÇK-65** En/W Boy/L Yük/H  
Dış / Ext 470 x 400 x 630 mm



85 Lt.

**ÇK-85** En/W Boy/L Yük/H  
Dış / Ext 470 x 450 x 730 mm



**ÇK-400 PD** 120 Lt.

Dış / Ext 480 x 530 x 950 mm



240 Lt.

**ÇK-500** En/W Boy/L Yük/H  
Dış / Ext 585 x 730 x 1100 mm



360 Lt.

**ÇK-600** En/W Boy/L Yük/H  
Dış / Ext 620 x 865 x 1100 mm



660 Lt.

**ÇK-660** En/W Boy/L Yük/H  
Dış / Ext 1200 x 780 x 1200 mm



770 Lt.

**ÇK-770** En/W Boy/L Yük/H  
Dış / Ext 1370 x 795 x 1310 mm



1100 Lt.

**ÇK-1100** En/W Boy/L Yük/H  
Dış / Ext 1360 x 1360 x 1330 mm

Sıfır Atık Geri Dönüşüm Kutuları  
Zero Waste Recycling BinsSticker'lı Modeller  
Models With Stickers

70 Lt.

ÇK-70 En/W Boy/L Yüksek/H  
Dış / Ext 402 x 362 x 721 mm



ÇK-70-3 En/W Boy/L Yüksek/H  
Dış / Ext 1500 x 362 x 721 mm  
ÇK-70-3 3'lü Sıfır Atık Kova Seti  
Zero Waste Bucket Set

Birleştirme Pimi  
coupling pinZemin Vidalama Yuvası  
Connecting Pin

90 Lt.

CP-90-M En/W Boy/L Yüksek/H  
350 x 350 x 710 mm



90 Lt.

CP-90-Y En/W Boy/L Yüksek/H  
350 x 350 x 710 mm



90 Lt.

CP-90-S En/W Boy/L Yüksek/H  
350 x 350 x 710 mm



90 Lt.

CP-90-G En/W Boy/L Yüksek/H  
350 x 350 x 710 mm



90 Lt.

CP-90-K En/W Boy/L Yüksek/H  
350 x 350 x 710 mm

PP Oluklu levha 2 mm kalınlık.

## PP Kova Stickerlar

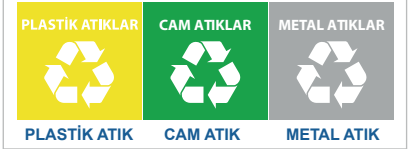

## ÇK-1812 4'lü Atık Kovası / Metal waste bins set

En/W Boy/L Yüksek/H

Dış / Ext 1150 x 300 x 650 mm

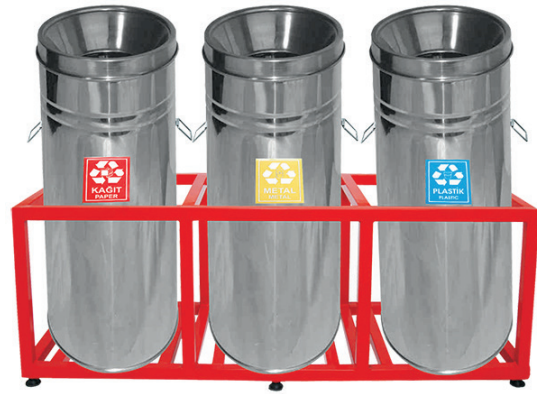

## ÇK-1811 3'lü Atık Kovası / Metal waste bins set

En/W Boy/L Yüksek/H

Dış / Ext 1230 x 420 x 1050 mm



## ÇK-1801 Atık Kovası

Metal waste bin

En/W Yüksek/H

Dış / Ext 240 x 600 mm

Paslanmaz / Stainless



## ÇK-1805 Atık Kovası

Metal waste bin

En/W Yüksek/H

Dış / Ext 350 x 1000 mm

Paslanmaz / Stainless



## ÇK-1825 4'lü Atık Kovası / Metal waste bins set

En/W Boy/L Yüksek/H

Dış / Ext 750 x 320 x 640 mm



Renk Seçenekleri / Color Options



Mavi / Blue



Kırmızı / Red



Gri / Grey

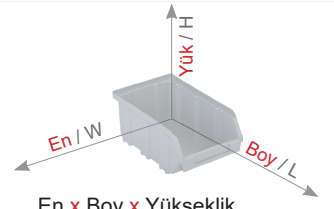

En x Boy x Yükseklik  
Width x Length x Height



**SV-309**

En/W Boy/L Yüksek/H

Dış / Ext 90 x 300 x 80 mm



**SV-409**

En/W Boy/L Yüksek/H

Dış / Ext 90 x 400 x 80 mm



**SV-9 B**

SV-309, SV-409 Şeffaf ara bölme  
SV-309, SV-409 Transparent separator



Taban / Base

SV-309, SV-409  
SV-319, SV-419



**SV-319**

En/W Boy/L Yüksek/H

Dış / Ext 188 x 300 x 80 mm



**SV-419**

En/W Boy/L Yüksek/H

Dış / Ext 188 x 400 x 80 mm



**SV-19 B**

SV-319, SV-419 Şeffaf ara bölme  
SV-319, SV-419 Transparent separator



**SV-609**

En/W Boy/L Yüksek/H

Dış / Ext 115 x 600 x 100 mm



**SV-619**

En/W Boy/L Yüksek/H

Dış / Ext 230 x 600 x 100 mm

Taban / Base

SV-609, SV-619



**SV-609 B**

SV-609 Ara bölme  
SV-609 Separator



**SV-619 B**

SV-619 Ara bölme  
SV-619 Separator



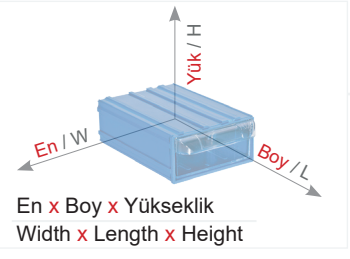

**102** *En/W Boy/L Yük/H*  
Dış / Ext 85 x 120 x 40 mm  
İç / Int 75 x 115 x 35 mm



**102 D** *En/W Boy/L Yük/H*  
Dış / Ext 85 x 120 x 80 mm  
İç / Int 75 x 115 x 35 mm



**202** *En/W Boy/L Yük/H*  
Dış / Ext 100 x 140 x 52 mm  
İç / Int 89 x 130 x 44 mm



**322** *En/W Boy/L Yük/H*  
Dış / Ext 96 x 140 x 125 mm  
İç / Int 89 x 130 x 58 mm



**132** *En/W Boy/L Yük/H*  
Dış / Ext 83 x 134 x 103 mm  
İç / Int 74 x 128 x 45 mm



**133** *En/W Boy/L Yük/H*  
Dış / Ext 83 x 134 x 103 mm  
İç / Int 74 x 128 x 30 mm



**136** *En/W Boy/L Yük/H*  
Dış / Ext 83 x 134 x 103 mm  
İç / Int 32 x 128 x 29 mm



132, 133 ve 136 birbirine monte edilebilir  
132,133 and 136 can be combined with each other



**141** *En/W Boy/L Yük/H*  
Dış / Ext 103 x 134 x 83 mm  
İç / Int 92 x 127 x 75 mm



**142** *En/W Boy/L Yük/H*  
Dış / Ext 103 x 134 x 83 mm  
İç / Int 92 x 127 x 35 mm



**144** *En/W Boy/L Yük/H*  
Dış / Ext 103 x 134 x 83 mm  
İç / Int 42 x 127 x 35 mm



141, 142 ve 144 birbirine monte edilebilir  
141,142 and 144 can be combined with each other



**302** *En/W Boy/L Yük/H*  
Dış / Ext 106 x 122 x 62 mm  
İç / Int 102 x 118 x 59 mm



**301** *En/W Boy/L Yük/H*  
Dış / Ext 106 x 122 x 62 mm  
İç / Int 102 x 118 x 25 mm



**305** *En/W Boy/L Yük/H*  
Dış / Ext 106 x 122 x 62 mm  
İç / Int 42 x 118 x 24 mm



301, 302 ve 305 birbirine monte edilebilir  
301,302 and 305 can be combined with each other



**351** *En/W Boy/L Yük/H*  
Dış / Ext 110 x 170 x 65 mm  
İç / Int 96 x 160 x 55 mm



**321** *En/W Boy/L Yük/H*  
Dış / Ext 125 x 140 x 96 mm  
İç / Int 114 x 130 x 84 mm



**325** *En/W Boy/L Yük/H*  
Dış / Ext 125 x 140 x 96 mm  
İç / Int 56 x 130 x 42 mm



321 ve 325 birbirine monte edilebilir  
321 and 325 can be combined with each other

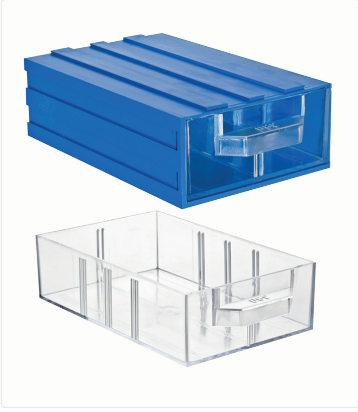

**390** *En/W Boy/L Yük/H*  
Dış / Ext 132 x 205 x 63 mm  
İç / Int 120 x 197 x 52 mm



**410** *En/W Boy/L Yük/H*  
Dış / Ext 132 x 205 x 83 mm  
İç / Int 120 x 197 x 75 mm



**420** *En/W Boy/L Yük/H*  
Dış / Ext 132 x 205 x 132 mm  
İç / Int 120 x 197 x 124 mm



390, 410 ve 420 birbirine monte edilebilir  
390,410 and 420 can be combined with each other



**401-A** *En/W Boy/L Yük/H*  
Dış / Ext 120 x 200 x 80 mm  
İç / Int 110 x 197 x 70 mm



**500-A** *En/W Boy/L Yük/H*  
Dış / Ext 140 x 230 x 98 mm  
İç / Int 125 x 221 x 85 mm



**451** *En/W Boy/L Yük/H*  
Dış / Ext 173 x 230 x 110 mm  
İç / Int 162 x 220 x 100 mm

En/W Boy/L Yüksek/H

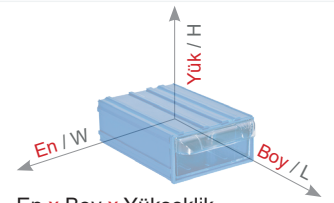

En x Boy x Yükseklik  
Width x Length x Height



En/W Boy/L Yüksek/H

**501-A** Dış / Ext 212 x 306 x 126 mm  
İç / Int 197 x 297 x 112 mm



En/W Boy/L Yüksek/H

**501-2** Dış / Ext 212 x 306 x 126 mm  
İç / Int 94 x 297 x 112 mm



En/W Boy/L Yüksek/H

**501-D** Dış / Ext 212 x 306 x 126 mm  
İç / Int 197 x 297 x 55 mm



501-A, 501-D ve 501-2 birbirine monte edilebilir

501-A, 501-D and 501-2 can be combined with each other



En/W Boy/L Yüksek/H

**501-AB** Dış / Ext 212 x 306 x 126 mm  
İç / Int 197 x 297 x 112 mm



En/W Boy/L Yüksek/H

**510** Dış / Ext 260 x 340 x 150 mm  
İç / Int 245 x 331 x 137 mm



En/W Boy/L Yüksek/H

**510-2** Dış / Ext 260 x 340 x 150 mm  
İç / Int 119 x 331 x 137 mm



En/W Boy/L Yüksek/H

**512** Dış / Ext 260 x 340 x 150 mm  
İç / Int 245 x 331 x 65 mm



En/W Boy/L Yüksek/H

**513** Dış / Ext 260 x 340 x 150 mm  
İç / Int 245 x 331 x 43 mm



510, 510-2 ve 513 birbirine monte edilebilir  
510, 510-2 and 513 can be combined with each other



**401-3** *En/W Boy/L Yük/H*  
Dış / Ext 360 x 200 x 155 mm  
İç / Int 110 x 195 x 143 mm



**401-3D** *En/W Boy/L Yük/H*  
Dış / Ext 125 x 200 x 155 mm  
İç / Int 110 x 195 x 143 mm



**401-6** *En/W Boy/L Yük/H*  
Dış / Ext 360 x 200 x 155 mm  
İç / Int 110 x 195 x 70 mm



**401-6D** *En/W Boy/L Yük/H*  
Dış / Ext 125 x 200 x 155 mm  
İç / Int 110 x 195 x 70 mm



**401-9** *En/W Boy/L Yük/H*  
Dış / Ext 360 x 200 x 155 mm  
İç / Int 110 x 195 x 44 mm



**401-9D** *En/W Boy/L Yük/H*  
Dış / Ext 125 x 200 x 155 mm  
İç / Int 110 x 195 x 44 mm



**401-4** *En/W Boy/L Yük/H*  
Dış / Ext 360 x 200 x 155 mm  
İç / Int 170 x 195 x 70 mm



401-3, 401-4 ve 401-9 birbirine monte edilebilir.  
401-3, 401-4 and 401-9 can be combined with each other

401-3D, 401-6D ve 401-9D birbirine monte edilebilir.  
401-3D, 401-6D and 401-9D can be combined with each other

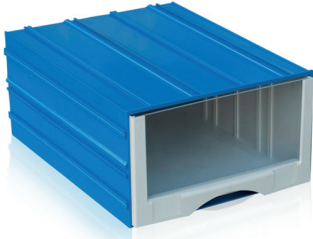

**450-G** *En/W Boy/L Yük/H*  
Dış / Ext 173 x 230 x 110 mm  
İç / Int 160 x 218 x 100 mm

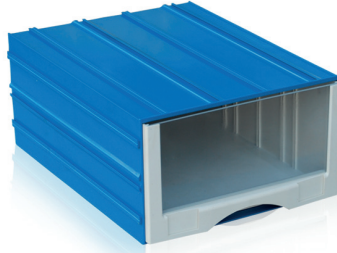

**501-G** *En/W Boy/L Yük/H*  
Dış / Ext 212 x 306 x 126 mm  
İç / Int 193 x 290 x 110 mm

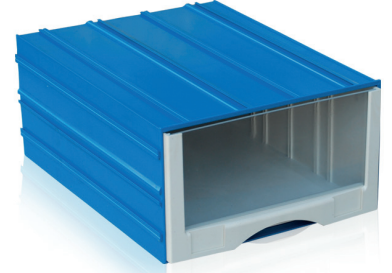

**511** *En/W Boy/L Yük/H*  
Dış / Ext 260 x 340 x 150 mm  
İç / Int 246 x 325 x 135 mm



**401-G** *En/W Boy/L Yük/H*  
Dış / Ext 120 x 200 x 80 mm  
İç / Int 110 x 190 x 70 mm



**500-G** *En/W Boy/L Yük/H*  
Dış / Ext 140 x 230 x 98 mm  
İç / Int 124 x 217 x 85 mm



**451-G** *En/W Boy/L Yük/H*  
Dış / Ext 173 x 230 x 110 mm  
İç / Int 160 x 218 x 100 mm

**Yasal Uyarı  
Legal Warning**

Tasarım tescil no: 2007 06461 401-G ve 500-G kodlu ürünler; Tasarım Tescil Belgesi ile Koruma altındadır. Kopyalanamaz ve çoğaltılamaz.  
Design registration No; 2007 06461. 401-G and 500-G Coded products are protected under design registration certificate and can not be copied or reproduced.



**MS-1** **MS-1 K**  
*En/W Boy/L Yük/H*  
Dış / Ext 100 x 80 x 110 mm  
İç / Int 80 x 70 x 100 mm



**MS-2** **MS-2 K**  
*En/W Boy/L Yük/H*  
Dış / Ext 120 x 110 x 160 mm  
İç / Int 100 x 95 x 145 mm



**MS-3** **MS-3 K**  
*En/W Boy/L Yük/H*  
Dış / Ext 150 x 140 x 205 mm  
İç / Int 125 x 130 x 187 mm



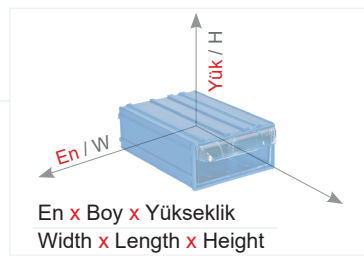

**MS-8009** *En/W Boy/L Yük/H*  
Dış / Ext 600 x 63 x 80 mm  
İç / Int 60 x 50 x 65 mm



**MS-8006** *En/W Boy/L Yük/H*  
Dış / Ext 600 x 94 x 112 mm  
İç / Int 94 x 70 x 100 mm



**MS-8005** *En/W Boy/L Yük/H*  
Dış / Ext 600 x 140 x 164 mm  
İç / Int 110 x 100 x 150 mm



**MS-8004** *En/W Boy/L Yük/H*  
Dış / Ext 600 x 168 x 208 mm  
İç / Int 140 x 130 x 190 mm



**MS-8003** *En/W Boy/L Yük/H*  
Dış / Ext 600 x 199 x 240 mm  
İç / Int 190 x 150 x 220 mm



**MS-8002** *En/W Boy/L Yük/H*  
Dış / Ext 600 x 305 x 354 mm  
İç / Int 285 x 225 x 335 mm



<b>MS-8100</b>				
	<i>En/W</i>	<i>Boy/L</i>	<i>Yük/H</i>	<i>Adet</i>
	<i>Dış / Ext</i>			<i>Piece</i>
MS-8009	60 x 50 x	65 mm	48	18
MS-8006	94 x 70 x	100 mm	6	6
MS-8005	110 x 100 x	150 mm	10	10
MS-8004	140 x 130 x	190 mm	8	8
MS-8003	190 x 150 x	220 mm	6	6



<b>MS-8200</b>				
	<i>En/W</i>	<i>Boy/L</i>	<i>Yük/H</i>	<i>Adet</i>
	<i>Dış / Ext</i>			<i>Piece</i>
MS-8009	60 x 50 x	65 mm	58	18
MS-8006	94 x 70 x	100 mm	12	12
MS-8005	110 x 100 x	150 mm	10	10
MS-8004	140 x 130 x	190 mm	8	8
MS-8003	190 x 150 x	220 mm	6	6
MS-8002	285 x 225 x	335 mm	4	4

# PLASTİK AVADANLIK KUTULAR

## PLASTIC STACKING BINS

Renk Seçenekleri / Color Options



Mavi / Blue



Sarı / Yellow



Kırmızı / Red



Gri / Grey

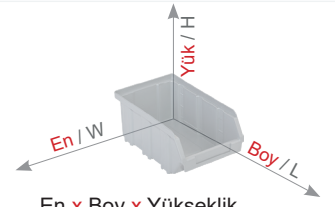

En x Boy x Yükseklik  
Width x Length x Height

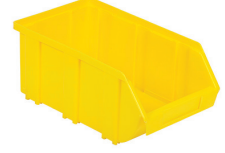

**A-400**

En/W Boy/L Yük/H

Dış / Ext 310 x 490 x 190 mm

**A-350**

En/W Boy/L Yük/H

Dış / Ext 260 x 420 x 170 mm

**A-300**

En/W Boy/L Yük/H

Dış / Ext 215 x 355 x 152 mm

**A-250**

En/W Boy/L Yük/H

Dış / Ext 172 x 305 x 130 mm



**A-200**

En/W Boy/L Yük/H

Dış / Ext 150 x 240 x 122 mm

**A-175**

En/W Boy/L Yük/H

Dış / Ext 125 x 253 x 98 mm

**A-150**

En/W Boy/L Yük/H

Dış / Ext 125 x 190 x 98 mm

**A-100**

En/W Boy/L Yük/H

Dış / Ext 102 x 170 x 74 mm



Ürün Kodu	Seperator Kodu
B-300	A-300
B-350	A-350
B-400	A-400



Ürün Kodu	Seperator Kodu
B-400 D	A-400



En/W Boy/L Yük/H

**A-500**

Dış / Ext 490 x 390 x 305 mm  
İç / İnt 430 x 325 x 300 mm



En/W Boy/L Yük/H

**A-530**

Dış / Ext 600 x 400 x 400 mm  
İç / İnt 530 x 330 x 395 mm



En/W Boy/L Yük/H

**A-530-T**

Dış / Ext 600 x 400 x 470 mm  
İç / İnt 530 x 330 x 395 mm

A-500 ve A-530 içiçe geçerek yerden tasarruf sağlar. Aparatları takılı iken üst üste durmaktadır.  
A-500 and A-530 save space while nested. They can also be stacked with optional attachments.

### Yasal Uyarı / Legal Warning

**Tasarım tescil no:** 2007 06461 A-500 ve A-530 kodlu ürünler; Tasarım Tescil Belgesi ile Koruma altındadır. Kopyalanamaz ve çoğaltılamaz.

**Design registration No:** Design registration No; 2007 06461. A-500 and A-530 Coded products are protected under design registration certificate and can not be copied or reproduced.







Mavi / Blue



Sarı / Yellow



Kırmızı / Red



Gri / Grey



**AV-550**

En/W Boy/L Yük/H

Dış / Ext 340 x 510 x 250 mm



**AV-540**

En/W Boy/L Yük/H

Dış / Ext 340 x 510 x 200 mm



**AV-520**

En/W Boy/L Yük/H

Dış / Ext 255 x 400 x 200 mm



**AV-515**

En/W Boy/L Yük/H

Dış / Ext 255 x 400 x 150 mm



**AV-415**

En/W Boy/L Yük/H

Dış / Ext 175 x 400 x 150 mm

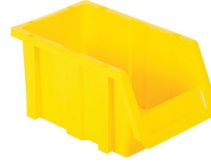

**AV-315**

En/W Boy/L Yük/H

Dış / Ext 175 x 300 x 150 mm

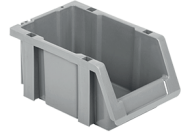

**AV-210**

En/W Boy/L Yük/H

Dış / Ext 130 x 200 x 100 mm



**AV-101**

Şeffaf Etiket / Transparent Label



**AV-102**

Yükseltme Pimi / Upgrade Pina



**AV-104**

Yükseltme Pimi / Upgrade Pina



**AV-103**

Birleştirme Pimi / Connecting Pina

Av-540 ve Av-550 Arka kısımlarından birbirine monte edilebilir.

Av-540 and Av-550 Can be connected back to back.

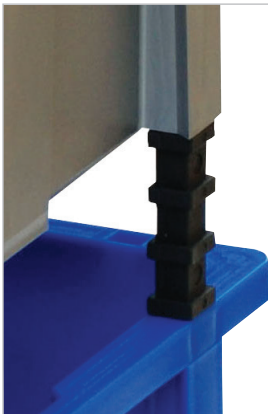

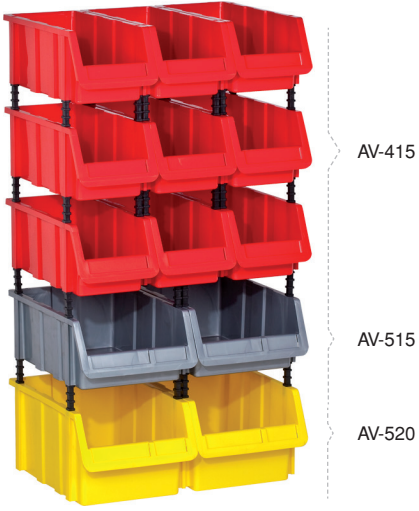

AV-415

AV-515

AV-520

**ST-1050**

*En/W Boy/L Yük/H*

Dış / Ext 510 x 400 x 1000 mm

Avadanlık Adedi / Equipment Piece : 13 Adet / Piece

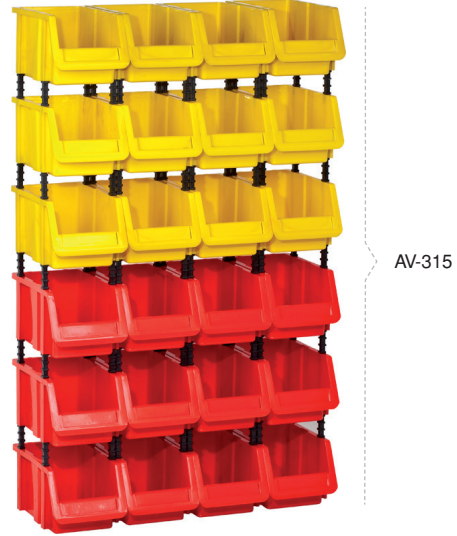

AV-315

**ST-1100**

*En/W Boy/L Yük/H*

Dış / Ext 700 x 300 x 1150 mm

Avadanlık Adedi / Equipment Piece : 24 Adet / Piece



AV-415

**ST-1120**

*En/W Boy/L Yük/H*

Dış / Ext 700 x 400 x 1150 mm

Avadanlık Adedi / Equipment Piece : 24 Adet / Piece



AV-415

AV-515

AV-520

AV-540

AV-550

**ST-1140**

*En/W Boy/L Yük/H*

Dış / Ext 1020 x 510 x 1350 mm

Avadanlık Adedi / Equipment Piece : 26 Adet / Piece



AV-415

AV-540

AV-550

**ST-1160**

*En/W Boy/L Yük/H*

**Dış / Ext** 680 x 510 x 1100 mm

Avadanlık Adedi / Equipment Piece : 16 Adet / Piece



AV-515

AV-520

**ST-1180**

*En/W Boy/L Yük/H*

**Dış / Ext** 765 x 400 x 1100 mm

Avadanlık Adedi / Equipment Piece : 15 Adet / Piece



AV-415

AV-540

AV-550

**ST-1200**

*En/W Boy/L Yük/H*

**Dış / Ext** 680 x 1020 x 1100 mm

Avadanlık Adedi / Equipment Piece : 32 Adet / Piece



AV-515

AV-520

**ST-1230**

*En/W Boy/L Yük/H*

**Dış / Ext** 765 x 800 x 1100 mm

Avadanlık Adedi / Equipment Piece : 30 Adet / Piece



En/W Boy/L Yük/H  
**TK-5034** 150 x 290 x 132 mm  
Koli Adedi / In Box : 36 Ad / Pcs



En/W Boy/L Yük/H  
**TK-1300** 165 x 300 x 135 mm  
Koli Adedi / In Box : 24 Ad / Pcs



En/W Boy/L Yük/H  
**TK-1400** 175 x 345 x 150 mm  
Koli Adedi / In Box : 24 Ad / Pcs



En/W Boy/L Yük/H  
**TK-1600** 215 x 400 x 180 mm  
Koli Adedi / In Box : 16 Ad / Pcs



En/W Boy/L Yük/H  
**TK-1620** 213 x 410 x 250 mm  
Koli Adedi / In Box : 9 Ad / Pcs



En/W Boy/L Yük/H  
**TK-5038** 202 x 390 x 235 mm  
Koli Adedi / In Box : 12 Ad / Pcs



En/W Boy/L Yük/H  
**TK-1900** 260 x 490 x 240 mm  
Koli Adedi / In Box : 9 Ad / Pcs



En/W Boy/L Yük/H  
**TK-1920** 260 x 490 x 320 mm  
Koli Adedi / In Box : 9 Ad / Pcs



En/W Boy/L Yük/H  
**TK-2200** 295 x 555 x 265 mm  
Koli Adedi / In Box : 7 Ad / Pcs



En/W Boy/L Yük/H  
**TK-2220** 375 x 570 x 375 mm  
Koli Adedi / In Box : 6 Ad / Pcs



En/W Boy/L Yük/H  
**TK-2250** 260 x 520 x 250 mm  
Koli Adedi / In Box : 6 Ad / Pcs



En/W Boy/L Yük/H  
**TK-2400** 300 x 620 x 282 mm  
Koli Adedi / In Box : 6 Ad / Pcs



En/W Boy/L Yük/H  
**TK-1700** 230 x 410 x 190 mm  
Koli Adedi / In Box : 12 Ad / Pcs

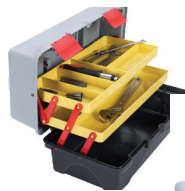

En/W Boy/L Yük/H  
**TK-2100** 255 x 485 x 258 mm  
Koli Adedi / In Box : 9 Ad / Pcs



En/W Boy/L Yük/H  
**TK-4025** 400 x 490 x 180 mm  
Koli Adedi / In Box : 4 Ad / Pcs  
Teknisyen çantası



En/W Boy/L Yük/H  
**TK-450-S** 358 x 460 x 185 mm  
Koli Adedi / In Box : 1 Ad / Pcs



En/W Boy/L Yük/H  
**TK-450** 358 x 460 x 185 mm  
Koli Adedi / In Box : 1 Ad / Pcs





En/W Boy/L Yük/H  
**TK-1310** 158 x 325 x 137 mm  
Koli Adedi / In Box : 24 Ad / Pcs



En/W Boy/L Yük/H  
**TK-1610** 213 x 410 x 195 mm  
Koli Adedi / In Box : 12 Ad / Pcs



En/W Boy/L Yük/H  
**TK-1630** 213 x 410 x 250 mm  
Koli Adedi / In Box : 9 Ad / Pcs



En/W Boy/L Yük/H  
**TK-1910** 260 x 490 x 240 mm  
Koli Adedi / In Box : 9 Ad / Pcs



En/W Boy/L Yük/H  
**TK-1930** 260 x 490 x 320 mm  
Koli Adedi / In Box : 6 Ad / Pcs



En/W Boy/L Yük/H  
**TK-1940** 260 x 490 x 256 mm  
Koli Adedi / In Box : 9 Ad / Pcs



En/W Boy/L Yük/H  
**TK-1950** 260 x 490 x 335 mm  
Koli Adedi / In Box : 6 Ad / Pcs



En/W Boy/L Yük/H  
**TK-2060** 283 x 500 x 248 mm  
Koli Adedi / In Box : 6 Ad / Pcs



En/W Boy/L Yük/H  
**TK-2210** 315 x 570 x 295 mm  
Koli Adedi / In Box : 6 Ad / Pcs



En/W Boy/L Yük/H  
**TK-2230** 315 x 570 x 375 mm  
Koli Adedi / In Box : 6 Ad / Pcs



En/W Boy/L Yük/H  
**TK-2260** 300 x 560 x 277 mm  
Koli Adedi / In Box : 6 Ad / Pcs



En/W Boy/L Yük/H  
**TK-2460** 314 x 676 x 300 mm  
Koli Adedi / In Box : 4 Ad / Pcs



En/W Boy/L Yük/H  
**903** 190 x 390 x 170 mm  
Koli Adedi / In Box : 12 Ad / Pcs



En/W Boy/L Yük/H  
**904** 190 x 390 x 215 mm  
Koli Adedi / In Box : 16 Ad / Pcs



En/W Boy/L Yük/H  
**905** 190 x 390 x 260 mm  
Koli Adedi / In Box : 20 Ad / Pcs



En/W Boy/L Yük/H  
**TK-2500-M** 400 x 625 x 420 mm  
Koli Adedi / In Box : 2 Ad / Pcs



En/W Boy/L Yük/H  
**TK-2500** 400 x 625 x 420 mm  
Koli Adedi / In Box : 2 Ad / Pcs



En/W Boy/L Yük/H  
**TK-4026** 500 x 725 x 465 mm  
Koli Adedi / In Box : 1 Ad / Pcs

725 x 500 x 465 mm



En/W Boy/L Yük/H  
**TK-5039** 330 x 485 x 635 mm  
Koli Adedi / In Box : 1 Ad / Pcs

485 x 330 x 635 mm



En/W Boy/L Yük/H  
**956** 335 x 390 x 62 mm  
Koli Adedi / In Box : 12 Ad / Pcs



En/W Boy/L Yük/H  
**955** 335 x 390 x 62 mm  
Koli Adedi / In Box : 16 Ad / Pcs



En/W Boy/L Yük/H  
**TK-5015** 130 x 330 x 250 mm  
Koli Adedi / In Box : 6 Ad / Pcs



En/W Boy/L Yük/H  
**TK-5016** 130 x 330 x 250 mm  
Koli Adedi / In Box : 6 Ad / Pcs

# PLASTİK ORGANİZER KUTULAR

## PLASTIC ORGANIZER BOXES



**607** En/W Boy/L Yüksek/H  
69 x 132 x 25 mm  
Bölme / W/dividers : 10 Bölmeli / Part



**605-A** En/W Boy/L Yüksek/H  
110 x 205 x 45 mm  
Bölme / W/dividers : 13 Bölmeli / Part



**606** En/W Boy/L Yüksek/H  
145 x 255 x 35 mm  
Bölme / W/dividers : 18 Bölmeli / Part



**613** En/W Boy/L Yüksek/H  
145 x 255 x 34 mm  
Bölme / W/dividers : 13 Bölmeli / Part



**616** En/W Boy/L Yüksek/H  
170 x 240 x 55 mm  
Bölme / W/dividers : 16 Bölmeli / Part



**TK-2094** En/W Boy/L Yüksek/H  
100 x 200 x 30 mm  
Bölme / W/dividers : 15 Bölmeli / Part



**TK-5017** En/W Boy/L Yüksek/H  
145 x 215 x 63 mm  
Bölme / W/dividers : 3 Bölmeli / Part



**610** En/W Boy/L Yüksek/H  
170 x 240 x 55 mm  
Bölme / W/dividers : 10 Bölmeli / Part



**728** En/W Boy/L Yüksek/H  
310 x 310 x 37 mm  
Bölme / W/dividers : 28 Bölmeli / Part



**844** En/W Boy/L Yüksek/H  
190 x 290 x 60 mm  
Bölme / W/dividers : 44 Bölmeli / Part



**714** En/W Boy/L Yüksek/H  
250 x 330 x 55 mm  
Bölme / W/dividers : 14 Bölmeli / Part



**724** En/W Boy/L Yüksek/H  
250 x 330 x 55 mm  
Bölme / W/dividers : 24 Bölmeli / Part



**730** En/W Boy/L Yüksek/H  
250 x 330 x 55 mm  
Bölme / W/dividers : 30 Bölmeli / Part



**951** En/W Boy/L Yüksek/H  
245 x 325 x 50 mm  
Bölme / W/dividers : 18 Bölmeli / Part



**952** En/W Boy/L Yüksek/H  
300 x 420 x 60 mm  
Bölme / W/dividers : 18 Bölmeli / Part



**953** En/W Boy/L Yüksek/H  
330 x 480 x 70 mm  
Bölme / W/dividers : 18 Bölmeli / Part

# PLASTİK ŞEFFAF KUTULAR VE SAKLAMA KAPLARI

## PLASTIC STORAGE BOXES



En/W Boy/L Yükseklik/H  
**HP-1** 54 x 80 x 23 mm



En/W Boy/L Yükseklik/H  
**HP-2** 80 x 120 x 36 mm



En/W Boy/L Yükseklik/H  
**HP-20** 65 x 95 x 50 mm



En/W Boy/L Yükseklik/H  
**HP-25** 90 x 120 x 50 mm



En/W Boy/L Yükseklik/H  
**HP-30** 105 x 155 x 65 mm



En/W Boy/L Yükseklik/H  
**HP-35** 150 x 205 x 75 mm



En/W Boy/L Yükseklik/H  
**HP-33** 123 x 200 x 68 mm



En/W Boy/L Yükseklik/H  
**HP-19** 150 x 150 x 40 mm



En/W Boy/L Yükseklik/H  
**HP-15** 72 x 72 x 48 mm



En/W Boy/L Yükseklik/H  
**HP-16** 97 x 48 x 48 mm



En/W Boy/L Yükseklik/H  
**HP-17** 72 x 150 x 48 mm



En/W Boy/L Yükseklik/H  
**HP-36** 110 x 150 x 75 mm  
Litresi / Liters : 0,5 Lt.



En/W Boy/L Yükseklik/H  
**HP-37** 140 x 210 x 75 mm  
Litresi / Liters : 1,2 Lt.



En/W Boy/L Yükseklik/H  
**HP-39** 140 x 210 x 105 mm  
Litresi / Liters : 1,5 Lt.



En/W Boy/L Yükseklik/H  
**HP-40** 165 x 255 x 120 mm  
Litresi / Liters : 2,8 Lt.



En/W Boy/L Yükseklik/H  
**HP-50** 200 x 300 x 135 mm  
Litresi / Liters : 5,0 Lt.



En/W Boy/L Yükseklik/H  
**HP-55** 250 x 375 x 155 mm  
Litresi / Liters : 9,5 Lt.



En/W Boy/L Yükseklik/H  
**HP-60** 310 x 450 x 185 mm  
Litresi / Liters : 17,5 Lt.



En/W Boy/L Yükseklik/H  
**HP-63** 320 x 460 x 290 mm  
Litresi / Liters : 30 Lt.



En/W Boy/L Yükseklik/H  
**HP-64** 390 x 620 x 335 mm  
Litresi / Liters : 50 Lt.



En/W Boy/L Yükseklik/H  
**HP-65** 400 x 600 x 380 mm  
Litresi / Liters : 75 Lt.



En/W Boy/L Yükseklik/H  
**HP-70** 515 x 800 x 420 mm  
Litresi / Liters : 120 Lt.



# PLASTİK RÖGAR KUTULARI

## PLASTIC MANHOLE BOXES



**LOGA 020** En/W Boy/L Yükseklik / H  
200 x 200 x 200 mm  
Çıkış Adedi / Connections : 4 Ad / Pcs



**LOGA 030** En/W Boy/L Yükseklik / H  
300 x 300 x 300 mm  
Çıkış Adedi / Connections : 4 Ad / Pcs



**LOGA 032** En/W Boy/L Yükseklik / H  
300 x 300 x 300 mm  
Çıkış Adedi / Connections : 6 Ad / Pcs



**LOGA 035** En/W Boy/L Yükseklik / H  
350 x 350 x 350 mm  
Çıkış Adedi / Connections : 4 Ad / Pcs



**LOGA 036** En/W Boy/L Yükseklik / H  
360 x 260 x 320 mm  
Çıkış Adedi / Connections : 6 Ad / Pcs



**LOGA 040** En/W Boy/L Yükseklik / H  
400 x 400 x 400 mm  
Çıkış Adedi / Connections : 4 Ad / Pcs



**LOGA 042** En/W Boy/L Yükseklik / H  
400 x 400 x 400 mm  
Çıkış Adedi / Connections : 6 Ad / Pcs



**LOGA 050** En/W Boy/L Yükseklik / H  
475 x 475 x 465 mm  
Çıkış Adedi / Connections : 4 Ad / Pcs



**LOGA 055** En/W Boy/L Yükseklik / H  
550 x 550 x 520 mm  
Çıkış Adedi / Connections : 4 Ad / Pcs

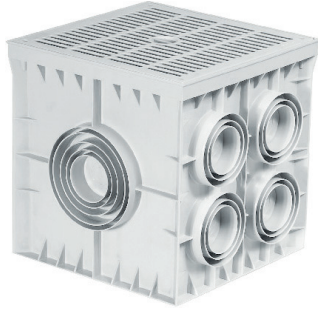

**LOGA 056** En/W Boy/L Yükseklik / H  
550 x 550 x 500 mm  
Çıkış Adedi / Connections : 10 Ad / Pcs

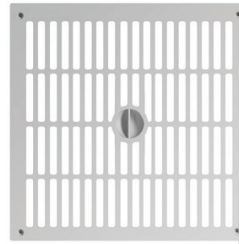

IZGARALI GRİ KAPAK  
PERFORATED GRAY  
COVER

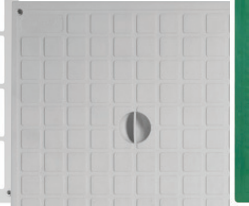

DÜZ GRİ KAPAK  
GRAY COVER

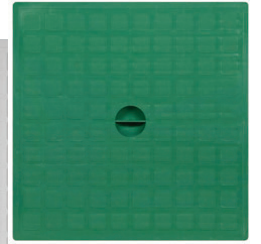

YEŞİL DÜZ KAPAK  
GREEN COVER

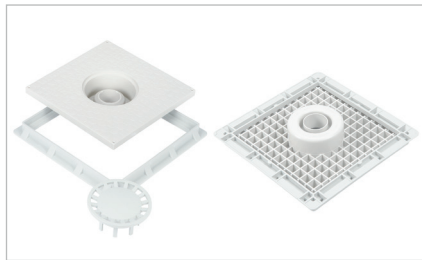

RÖGAR KAPAK VE ÇERÇEVELERİ  
MANHOLE COVER AND FRAMES



**LOGA 130-SG**  
En/W Boy/L Yükseklik / H  
300 x 300 x 90 mm



**LOGA 140-SG**  
En/W Boy/L Yükseklik / H  
400 x 400 x 90 mm



**LOGA 120**  
En/W Boy/L Yükseklik / H  
200 x 200 x 30 mm



**LOGA 130**  
En/W Boy/L Yükseklik / H  
300 x 300 x 40 mm



**LOGA 140**  
En/W Boy/L Yükseklik / H  
400 x 400 x 45 mm



**LOGA 155**  
En/W Boy/L Yükseklik / H  
550 x 550 x 65 mm



**LOGA 170**  
En/W Boy/L Yükseklik / H  
700 x 700 x 65 mm

Trafik Koni ve Dikmeleri  
Traffic Cones And Poles

Koni ve dubalara lamba ve levha takılabilir.  
Light and boards can be applied



<b>12302 TK</b>	350 x 500 mm
Material	PPC
Ağırlık / Weight	0,85 Kg

<b>12300 TK</b>	350 x 500 mm
Material	PPC
Ağırlık / Weight	1,15 Kg

<b>12301 TK</b>	350 x 520 mm
Material	PPC
Ağırlık / Weight	4,00 Kg

Ağırlıklı Taban  
Ballasted base

<b>12350 TK</b>	370 x 600 mm
Material	PPC
Ağırlık / Weight	1,50 Kg

<b>12351 TK</b>	350 x 613 mm
Material	PPC
Ağırlık / Weight	5,15 Kg

Ağırlıklı Taban  
Ballasted base

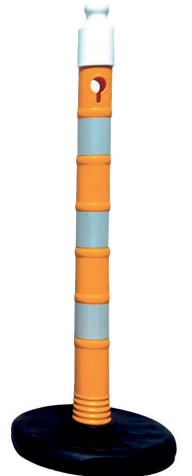

<b>12401 DB</b>	Ø63 x 1000 mm
Material	PPC-PVC Compuant
Ağırlık / Weight	4,00 Kg

<b>12403 DBR</b>	Ø63 x 1000 mm
Material	PPC-PVC Compuant
Ağırlık / Weight	4,00 Kg

<b>12409 DBR</b>	Ø63 x 1000 mm
Material	PPC-PVC Compuant
Ağırlık / Weight	4,00 Kg

<b>12420 DBR</b>	Ø83 x 1100 mm
Material	PPC-PVC Compuant
Ağırlık / Weight	6,50 Kg

<b>12422 DBR</b>	Ø80 x 1100 mm
Material	PPC-PVC Compuant
Ağırlık / Weight	6,50 Kg



<b>12428 DB</b>	Ø140 x 1200 mm
Material	PPC - PVC
Ağırlık / Weight	8,70 Kg

<b>12430 DB</b>	Ø140 x 1200 mm
Material	PPC - PVC
Ağırlık / Weight	8,70 Kg

<b>12402 DB</b>	Ø110 x 1200 mm
Material	PPC
Ağırlık / Weight	12,00 Kg

<b>12404 DB</b>	Ø110 x 1200 mm
Material	PPC
Ağırlık / Weight	12,00 Kg

<b>12414 DB</b>	Ø110 x 1200 mm
Material	PPC
Ağırlık / Weight	12,00 Kg

PVC Esnek Trafik Konileri  
PVC Flexible Traffic Cones



**12303 TK R1**  
220 x 320 mm  
Ağırlık / Weight 0,65 Kg

**12306 TK R1**  
285 x 500 mm  
Ağırlık / Weight 1,30 Kg

**12326 TKA R1**  
385 x 500 mm  
Ağırlık / Weight 2,65 Kg  
Ağırlıklı Taban  
Ballasted base

**12330 TK R1**  
320 x 520 mm  
Ağırlık / Weight 1,25 Kg

**12332 TK R1**  
320 x 520 mm  
Ağırlık / Weight 1,25 Kg

**12335 TK R1**  
380 x 700 mm  
Ağırlık / Weight 2,30 Kg



**12337 TK R2**  
380 x 700 mm  
Ağırlık / Weight 2,30 Kg

**12309 TK R2**  
385 x 750 mm  
Ağırlık / Weight 3,20 Kg

**12315 TKA R2**  
485 x 750 mm  
Ağırlık / Weight 6,50 Kg  
Ağırlıklı Taban  
Ballasted base

**12325 TK R2**  
385 x 900 mm  
Ağırlık / Weight 3,60 Kg

**12327 TKA R2**  
485 x 900 mm  
Ağırlık / Weight 6,90 Kg  
Ağırlıklı Taban  
Ballasted base

**126 A**  
Levha ve Lamba Aparatı  
Board and light connector



**12270 UBR** 1000 x 220 x 455 mm  
Material PPC Taban - TPU Delinator  
Ağırlık / Weight 3,85 Kg

**12266 UBR** 1000 x 220 x 650 mm  
Material PPC  
Ağırlık / Weight 3,60 Kg

Ø18x L90 xØ10 mm vida ve dübel ile zemine uygulama yapılabilir.  
Ürünler için gerekli vida ve dübeller paket içinde bulunmaktadır.  
Can be fixed to the ground with the Ø18x L90 xØ10 mm screw and wall plug  
The necessary screw and wall plug for the related product are in the package.

Esnek Yol Ayırıcı Delinatörler  
Flexible Delineators



<b>12211 UBR</b>	Ø80 x 1000 mm
Material	TPU
Ağırlık / Weight	1,60 Kg



<b>12212 UBR</b>	Ø80 x 750 mm
Material	TPU
Ağırlık / Weight	1,30 Kg



<b>12214 UBR</b>	Ø80 x 450 mm
Material	TPU
Ağırlık / Weight	0,98 Kg



<b>12215 UBR</b>	Ø80 x 300 mm
Material	TPU
Ağırlık / Weight	0,72 Kg



<b>194 A</b>	Levha ve Lamba Aparatı
	Board and light connector



<b>12237 UBR</b>	Ø110 x 750 mm
Material	TPU
Ağırlık / Weight	2,10 Kg



<b>12243 UBR</b>	Ø90 x 750 mm
Material	TPU
Ağırlık / Weight	1,50 Kg



<b>12247 UBR</b>	Ø80 x 500 mm
Material	TPU
Ağırlık / Weight	1,00 Kg



<b>12281 UBR</b>	Ø80 x 700 mm
Material	TPU-PU
Ağırlık / Weight	1,00 Kg



<b>12283 UBR</b>	Ø80 x 400 mm
Material	TPU-PU
Ağırlık / Weight	0,70 Kg



<b>12255 UBR</b>	120 x 450 mm
Material	TPU
Ağırlık / Weight	950 Gr



<b>12258 UBR</b>	120 x 450 mm
Material	TPU
Ağırlık / Weight	950 Gr



<b>12257 UBR</b>	120 x 750 mm
Material	TPU
Ağırlık / Weight	1,40 Kg



<b>12256 UBR</b>	120 x 750 mm
Material	TPU-PU
Ağırlık / Weight	1,40 Kg



<b>12253 UBR</b>	120 x 750 mm
Material	TPU-PU
Ağırlık / Weight	1,40 Kg

Bu sayfadaki ürünler Ø18x L90 xØ10 mm vida ve dübel ile zemine uygulama yapılabilir.  
Ürünler için gerekli vida ve dübeller paket içinde bulunmaktadır.

Can be fixed to the ground with the Ø18x L90 xØ10 mm screw and wall plug  
The necessary screw and wall plug for the related product are in the package.

Uyarı Levha, Lamba ve Aynaları

Warning boards, solar flasher lights and mirrors



120 A Ø 280 mm



110 A 390 mm



113 A 300 x 300 mm



114 A 315 x 340 mm



196 A Ø 380 mm



111 A 350 x 410 mm



124 AF Ø 280 mm



295 AF Ø 380 mm



131 AR 390 mm



221 AR Ø 380 mm

İki yönlü uyarı / Two-way Warning



11811 FLS



11813 FLK



11827 FLK



11813 FLS



11817 FLK



11819 FLS



11821 FLM

90 X 235 X 290 mm  
Açma kapama düğmesi  
4+4 led iki yönde uyarı

Power switch  
4 + 4 led two-way warning

90 X 215 X 290 mm  
Açma kapama düğmesi  
8 led tek yönde uyarı

Power switch  
8 led single way warning

(ØxH) 128 X 145 MM

6 led Dairesel uyarı

6 led Circular warning



12228 TGA

Ø 600 mm

Material PPC - Akriik

Ağırlık / Weight 4,00 Kg



12226 TGA

Ø 800 mm

Material PPC - Akriik

Ağırlık / Weight 6,00 Kg



12267 TGA

400 x 600 mm

Material ABS - Akriik

Ağırlık / Weight 3,60 Kg



12248 TGA

600 x 800 mm

Material ABS - Akriik

Ağırlık / Weight 5,60 Kg



Vakum teknolojisi ile Akriik Ayna  
UV ışınlarına dayanıklı ve esnek.  
Dış ortam şartlarına uyumlu sağlamlıktadır.

Acrylic Mirror with Vacuum Technology  
Resistant to UV rays and flexible.  
Consistent with outdoor conditions.

Vakum teknolojisi ile Akriik Ayna  
UV ışınlarına dayanıklı ve esnek.  
Dış ortam şartlarına uyumlu sağlamlıktadır.

Acrylic Mirror with Vacuum Technology  
Resistant to UV rays and flexible.  
Consistent with outdoor conditions.

Plastik Güvenlik Bariyerleri  
Plastic Safety Barriers



<b>12510 FBR</b>	Boy/L Yüksek/H 1500 x 1000 mm
Material	PVC Ayak / Feet PPC Gövde / Board
Ağırlık / Weight	12,30 Kg



<b>12500 FBR</b>	Boy/L Yüksek/H 900 x 1500 mm
Material	PVC Ayak / Feet PPC Gövde / Board
Ağırlık / Weight	18,00 Kg



<b>12417 DBR</b>	En/W Boy/L Yüksek/H 480 x 600 x 900 mm
Material	PVC Ayak / Feet PPC Gövde / Board
Ağırlık / Weight	12,00 Kg

Otopark Kolon Köşe Koruyucuları  
Car Park Corner Cover



<b>12292 UBR</b>	En/W Boy/L Yüksek/H 90 x 140 x 900 mm
Material	PVC - PE
Ağırlık / Weight	1,85 Kg



<b>12294 UBR</b>	En/W Boy/L Yüksek/H 70 x 120 x 800 mm
Material	PVC
Ağırlık / Weight	1,90 Kg



<b>12296 UBR</b>	En/W Boy/L Yüksek/H 80 x 120 x 800 mm
Material	PVC
Ağırlık / Weight	1,90 Kg



<b>KZ-1</b>	En/W Boy/L Yüksek/H 215x 630 x 340 mm
Material	ABS
Ağırlık / Weight	1,21 Kg



175 A Zincir Klipsi



<b>128 A</b>	En/W Boy/L Yüksek/H Kırmızı Beyaz, Plastik Zincir Red White Plastic Chain
--------------	---

Ø18x L90 xØ10 mm plastik vida dübel ile zemine uygulanır. Can be fixed to the wall with the Ø18x L90 xØ10 mm screw and wall plug

Araç Stopeler  
Car Stoppers

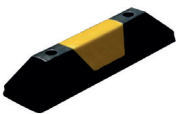

<b>12235 UB</b>	En/W Boy/L Yüksek/H 500 x 150 x 100 mm
Material	PPC
Ağırlık / Weight	1,90 Kg

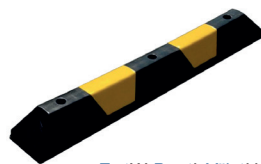

<b>12233 UB</b>	En/W Boy/L Yüksek/H 1100 x 150 x 100 mm
Material	PPC
Ağırlık / Weight	4,25 Kg

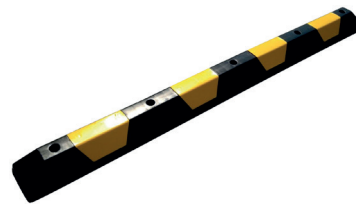

<b>12231 UB</b>	En/W Boy/L Yüksek/H 1800 x 150 x 100 mm
Material	PPC
Ağırlık / Weight	6,80 Kg



<b>12216 UB</b>	En/W Boy/L Yüksek/H 500 x 160 x 100 mm
Material	PPC
Ağırlık / Weight	2,45 Kg

Ø18x L90 xØ10 mm plastik vida dübel ile zemine uygulanır. Can be applied to the floor with the Ø18x L90 xØ10 mm screw and wall plug. Ürünler için gerekli vida ve dübelleri paket içinde bulunmaktadır. The necessary screw and wall plug for the related product are in the package.

Yol Kasisleri  
Speed Bumps



**12101 YKK**  
Kapak / Lid  
En/W Boy/L Yüksek/H  
250 x 100 x 50 mm  
Ağırlık / Weight  
0,36 Kg  
Material : PPC



**12102 YK**  
En/W Boy/L Yüksek/H  
300 x 330 x 40 mm  
Ağırlık / Weight  
1,30 Kg  
Material : PPC

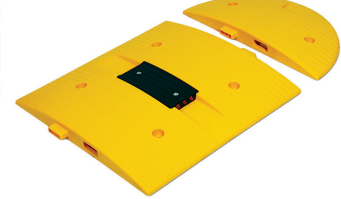

**12112 YK**  
En/W Boy/L Yüksek/H  
500 x 500 x 45 mm  
Ağırlık / Weight  
3,10 Kg  
Material : PPC

**12113 YKK**  
Kapak / Lid  
En/W Boy/L Yüksek/H  
500 x 250 x 45 mm  
Ağırlık / Weight  
1,10 Kg  
Material : PPC

**12100 YK**  
En/W Boy/L Yüksek/H  
250 x 350 x 50 mm  
Ağırlık / Weight  
1,50 Kg  
Material : PPC



**11940 SLK**  
Kapak / Lid  
En/W Boy/L Yüksek/H  
500 x 250 x 45 mm  
Ağırlık / Weight  
1,10 Kg



**12104 YK**  
En/W Boy/L Yüksek/H  
500 x 330 x 45 mm  
Ağırlık / Weight  
6,25 Kg  
Material  
Kauçuk şase PVC  
Compoud / Rubber

**12105 YKK**  
Kapak / Lid  
En/W Boy/L Yüksek/H  
500 x 250 x 45 mm  
Ağırlık / Weight  
3,00 Kg

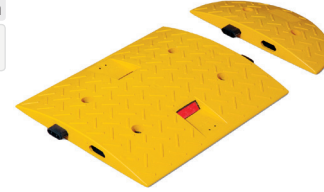

**12106 YK**  
En/W Boy/L Yüksek/H  
400 x 500 x 40 mm  
Ağırlık / Weight  
6,50 Kg  
Material  
Kauçuk şase PVC  
Compoud / Rubber

**12107 YKK**  
Kapak / Lid  
En/W Boy/L Yüksek/H  
400 x 200 x 40 mm  
Ağırlık / Weight  
1,65 Kg

**11938 SL**  
En/W Boy/L Yüksek/H  
500 x 500 x 45 mm  
Ağırlık / Weight  
3,10 Kg  
Material : PPC  
Solar Güçlü Çalışan 6 Led.  
Solar Powered Warning Flasher.



**12109 YKK**  
Kapak / Lid  
En/W Boy/L Yüksek/H  
600 x 300 x 45 mm  
Ağırlık / Weight  
3,40 Kg



**12110 YK**  
En/W Boy/L Yüksek/H  
400 x 500 x 40 mm  
Ağırlık / Weight  
6,50 Kg  
Material  
Kauçuk şase PVC  
Compoud / Rubber

**12111 YKK**  
Kapak / Lid  
En/W Boy/L Yüksek/H  
400 x 200 x 40 mm  
Ağırlık / Weight  
1,65 Kg



**12290 UB**  
En/W Boy/L Yüksek/H  
500 x 500 x 60 mm  
Ağırlık / Weight  
7,30 Kg  
Material  
Metal PPC

**12291 UBK**  
Kapak / Lid  
En/W Boy/L Yüksek/H  
500 x 90 x 60 mm  
Ağırlık / Weight  
0,70 Kg

**12108 YK**  
En/W Boy/L Yüksek/H  
600 x 500 x 45 mm  
Ağırlık / Weight  
9,30 Kg  
Material  
Kauçuk şase PVC  
Compoud / Rubber

Bu sayfadaki ürünler yanyana ilave edilerek Ø18 X L90 X Ø10 mm vida ve dübel ile zemine uygulama yapılabilir. Ürünler için gerekli vida ve dübeller paket içinde bulunmaktadır.  
Can be connected each other and fixed to the ground with the Ø18x L90 xØ10 mm screw and wall plug for the related product are in the package.

Plastik Güvenlik Bariyerleri  
Plastic Safety Barriers



Levhali Uyarıcı  
Warning flap

<b>12522 FBR</b>	En/W Boy/L Yüksek/H	400 x 1000 x 600 mm
Material	PPC - PVC	
Ağırlık / Weight	20,00 Kg	



Kedi gözlü uyarıcı  
Warning reflector

<b>12520 FBR</b>	En/W Boy/L Yüksek/H	400 x 1000 x 600 mm
Material	PPC - PVC	
Ağırlık / Weight	20,00 Kg	



Flaşörlü Uyarıcı  
Warning flasher

<b>12526 FBR</b>	En/W Boy/L Yüksek/H	400 x 1000 x 600 mm
Material	PPC - PVC	
Ağırlık / Weight	20,00 Kg	



Delinatörlü Uyarıcı  
Warning delineator

<b>12524 FBR</b>	En/W Boy/L Yüksek/H	400 x 1000 x 600 mm
Material	PPC - PVC	
Ağırlık / Weight	20,00 Kg	



Renk Seçenekleri Color Options



Özellikler Options

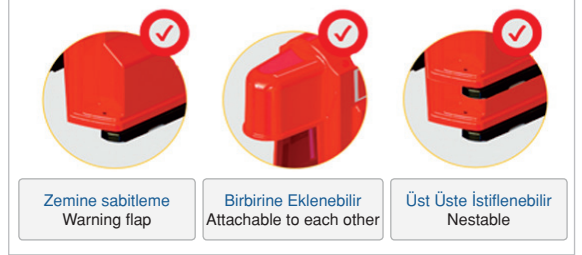

<b>12423 DB RA</b>	En/W Boy/L Yüksek/H	495 x 395 x 905 mm
Material	PPC - PVC	
Ağırlık / Weight	7,50 Kg	

<b>12425 DB RA</b>	En/W Boy/L Yüksek/H	495 x 395 x 905 mm
Material	PPC - PVC	
Ağırlık / Weight	7,50 Kg	

İki yönlü uyarı / Two-way Warning



<b>12424 DB RA</b>	En/W Boy/L Yüksek/H	495 x 395 x 905 mm
Material	PPC - PVC	
Ağırlık / Weight	7,50 Kg	

<b>12426 DB A</b>	En/W Boy/L Yüksek/H	495 x 395 x 905 mm
Material	PPC - PVC	
Ağırlık / Weight	7,50 Kg	



Yivli Soket  
Screwed Socket



Elle Kavrama Yuvaları  
Handle Grips



Zincir Geçirme Kanalı  
Chain Crossing Channel



Ağırlıklı Taban  
Ballasted base



Üst Üste istiflenir  
Nestable



Alternatif 1  
Alternative 1



Alternatif 2  
Alternative 2



Alternatif 3  
Alternative 3



Plastik Güvenlik Bariyerleri  
Plastic Safety Barriers

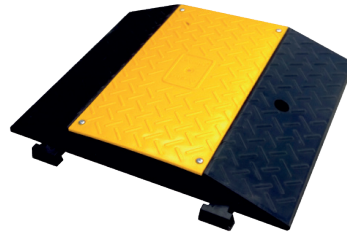

<i>En/W Boy/L Yüksek/H</i>	
<b>12298 UB</b>	600 x 500 x 75 mm
Material	PPC/ PVC
Ağırlık / Weight	8,70 Kg

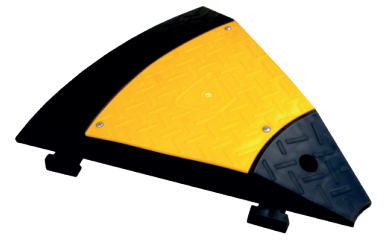

<i>En/W Boy/L Yüksek/H</i>	
<b>12299 UB</b>	600 x 500 x 75 mm
Material	PPC
Ağırlık / Weight	3,00 Kg

3 Kanallı Kablo Koruyucu Kasis ve Köşesi  
Bump and corner with 3 cable channels.

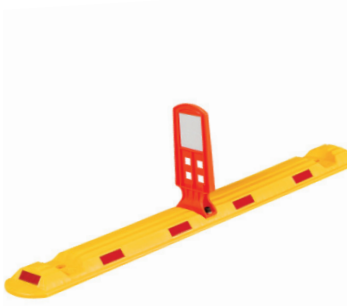
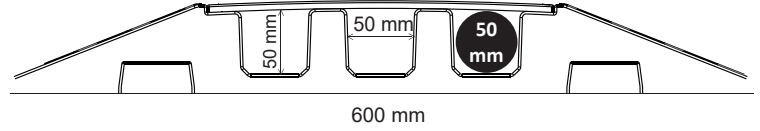
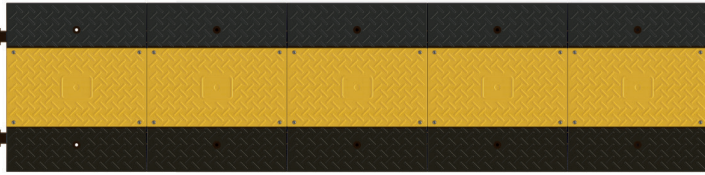
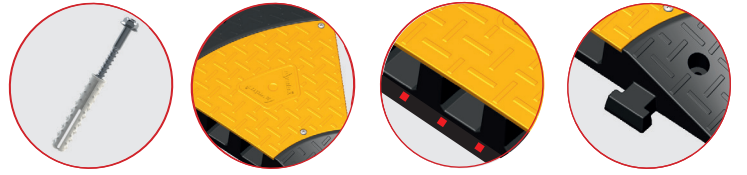
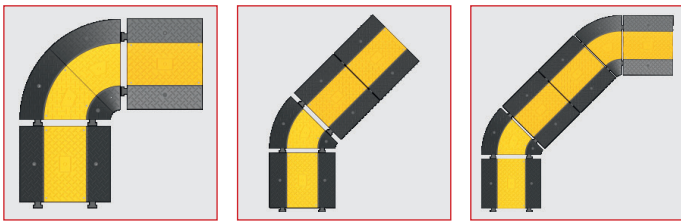

<i>En/W Boy/L Yüksek/H</i>	
<b>12203 UBR</b>	1200 x 150 x 280 mm
Material	PE-PPC
Ağırlık / Weight	2,50 Kg



<i>En/W Boy/L Yüksek/H</i>	
<b>12204 UBR</b>	1200 x 150 x 600 mm
Material	PE-PPC
Ağırlık / Weight	2,70 Kg



<i>En/W Boy/L Yüksek/H</i>	
<b>12207 UBR</b>	260 x 160 x 280 mm
Material	PE-PPC
Ağırlık / Weight	0,750 Kg



<i>En/W Boy/L Yüksek/H</i>	
<b>12206 UBR</b>	260 x 160 x 600 mm
Material	PE-PPC
Ağırlık / Weight	0,900 Kg

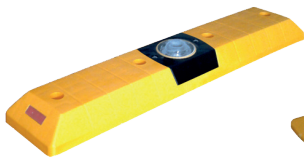

<b>12217 UB</b>	
<i>En/W Boy/L Yüksek/H</i>	
1000 x 200 x 80 mm	
Material	PPC
Ağırlık / Weight	4,10 Kg



<b>12262 UB</b>	
<i>En/W Boy/L Yüksek/H</i>	
1000 x 220 x 90 mm	
Material	PPC
Ağırlık / Weight	3,50 Kg



<b>12261 UB</b>	
<i>En/W Boy/L Yüksek/H</i>	
550 x 150 x 100 mm	
Material	PPC
Ağırlık / Weight	1,90 Kg



<b>12263 UB</b>	
<i>En/W Boy/L Yüksek/H</i>	
1100 x 150 x 100 mm	
Material	PPC
Ağırlık / Weight	4,20 Kg



<b>12202 UB</b>	
<i>En/W Boy/L Yüksek/H</i>	
1200 x 150 x 50 mm	
Material	PPC
Ağırlık / Weight	2,30 Kg

Yol Butonları  
Road Markers

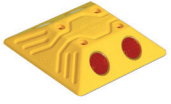

12000 YB

En / W Boy / L Yüksek / H  
125 x 150 x 32 mm

Material PPC

Ağırlık / Weight 0,20 Kg



12002 YB

En / W Boy / L Yüksek / H  
120 x 120 x 28 mm

Material PPC

Ağırlık / Weight 0,18 Kg



12003 YB

En / W Boy / L Yüksek / H  
100 x 220 x 32 mm

Material PPC

Ağırlık / Weight 0,24 Kg



12004 YB

En / W Boy / L Yüksek / H  
120 x 140 x 25 mm

Material PPC

Ağırlık / Weight 0,12 Kg



12005 YB

En / W Boy / L Yüksek / H  
105 x 105 x 21 mm

Material PPC

Ağırlık / Weight 0,11 Kg



12006 YB

En / W Boy / L Yüksek / H  
120 x 220 x 28 mm

Material PPC

Ağırlık / Weight 0,22 Kg



12009 YB

En / W Boy / L Yüksek / H  
100 x 100 x 21 mm

Material ABS

Ağırlık / Weight 0,15 Kg



12007 YB

En / W Boy / L Yüksek / H  
120 x 120 x 28 mm

Material Aluminium

Ağırlık / Weight 0,29 Kg



12011 YB

En / W Boy / L Yüksek / H  
120 x 140 x 21 mm

Material Aluminium

Ağırlık / Weight 0,37 Kg



11920 SLK

En / W Boy / L Yüksek / H  
125 x 145 x 28 mm

Material Aluminium

Ağırlık / Weight 0,45 Kg

Solar 3+3 Led

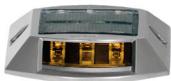

11922 SLS

En / W Boy / L Yüksek / H  
125 x 145 x 28 mm

Material Aluminium

Ağırlık / Weight 0,45 Kg

Solar 3+3 Led



11924 SLK

En / W Boy / L Yüksek / H  
125 x 145 x 28 mm

Material Aluminium

Ağırlık / Weight 0,45 Kg

Solar 3+3 Led

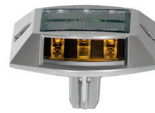

11926 SLS

En / W Boy / L Yüksek / H  
125 x 145 x 28 mm

Material Aluminium

Ağırlık / Weight 0,48 Kg

Solar 3+3 Led

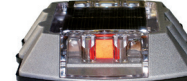

11921 SLK

En / W Boy / L Yüksek / H  
120 x 135 x 28 mm

Material Aluminium

Ağırlık / Weight 0,57 Kg

Solar 3+3 Led



11923 SLS

En / W Boy / L Yüksek / H  
120 x 135 x 28 mm

Material Aluminium

Ağırlık / Weight 0,57 Kg

Solar 3+3 Led

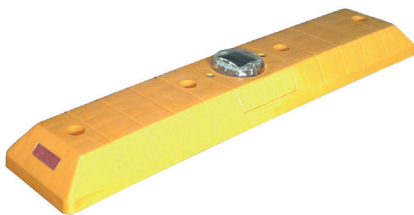

12220 UB

En / W Boy / L Yüksek / H  
1000 x 200 x 80 mm

Material PPC

Ağırlık / Weight 3,70 Kg

Solar 3+3 Led



12262 UB

En / W Boy / L Yüksek / H  
1000 x 220 x 80 mm

Material PPC

Ağırlık / Weight 3,50 Kg

Solar 3+3 Led

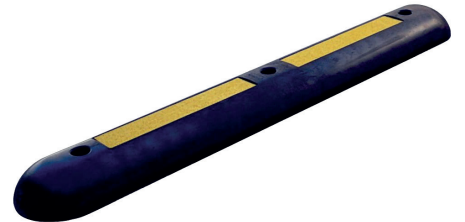

12260 UBR

En / W Boy / L Yüksek / H  
1000 x 150 x 60 mm

Material PVC

Ağırlık / Weight 6,00 Kg

Reflektif Bant

Reflective Stripe

Plastik Güvenlik Bariyerleri  
Plastic Safety Barriers



Şömiş Çerçeve Renkleri  
Wrapper frame colors

ŞDP-10 ŞDP-5

Dikey Şömiş / Vertical Pocket  
ŞM-1-A4  
ŞM-1-A5  
ŞM-1-A3

Döküm Ayaklı Taşıyıcılar  
Cast Footed Floor Stand  
Şömiş Adet / Pocket Pcs

ŞP-5	5 Adet / Piece
ŞP-10	10 Adet / Piece
ŞP-15	15 Adet / Piece
ŞP-20	20 Adet / Piece
ŞP-25	25 Adet / Piece

ŞDP-10-A4  
Plastik Duvar Tipi 10'lu Taşıyıcı  
Plastic Wall Unit For 10 Pockets

ŞDP-5-A4  
Plastik Duvar Tipi 5'li Taşıyıcı  
Plastic Wall Unit For 5 Pockets

ŞD-5 ve ŞD-10 Yanyana Takılabilir  
SDP-5 and SDP-10 combinations  
can be created

Yatay Şömiş  
Horizontal Pocket  
ŞM-1-Y

Duvar Tipi A5 Metal Taşıyıcı  
Wall Mounted A5 Metal Carrier

Kod / Code	Şömiş Adet / Pocket Pcs
ŞD5-5	5 Adet / Piece
ŞD5-10	10 Adet / Piece
ŞD5-15	15 Adet / Piece
ŞD5-20	20 Adet / Piece
ŞD5-25	25 Adet / Piece

Duvar Tipi A4 Metal Taşıyıcı  
Wall Mounted A4 Metal Carrier

Kod / Code	Şömiş Adet / Pocket Pcs
ŞD4-5	5 Adet / Piece
ŞD4-10	10 Adet / Piece
ŞD4-15	15 Adet / Piece
ŞD4-20	20 Adet / Piece
ŞD4-25	25 Adet / Piece

Duvar Tipi A3 Metal Taşıyıcı  
Wall Mounted A3 Metal Carrier

Kod / Code	Şömiş Adet / Pocket Pcs
ŞD3-5	5 Adet / Piece
ŞD3-10	10 Adet / Piece
ŞD3-15	15 Adet / Piece
ŞD3-20	20 Adet / Piece
ŞD3-25	25 Adet / Piece

Masaüstü Taşıyıcı  
Desk Stand

Kod / Code	Şömiş Adet / Pocket Pcs
ŞM-5	5 Adet / Piece
ŞM-10	10 Adet / Piece
ŞM-15	15 Adet / Piece
ŞM-20	20 Adet / Piece
ŞM-25	25 Adet / Piece

Teleskopik Masaüstü Taşıyıcı  
Telescopic Desk Unit

Kod / Code	Şömiş Adet / Pocket Pcs
ŞA-5	5 Adet / Piece
ŞA-10	10 Adet / Piece
ŞA-15	15 Adet / Piece
ŞA-20	20 Adet / Piece
ŞA-25	25 Adet / Piece



# Hi-paş

PLASTİK



2019 Plastik Ürünler ve Endüstriyel Ürünler Kataloğu Kataloğlarımızı Pdf'lerini web sitemizden indirebilirsiniz.  
2019 Plastic Products and Industrial Products Catalogue You can download the PDFs of our catalogues from our website.

## HİPAŞ PLASTİK EŞYA TİC. VE SAN. LTD. ŞTİ.

Söleyman Demirel Bulvarı 23.Cadde Heskop San. Sit.

S.1 Blok Z.1-2 İkitelli Org. San. Başakşehir / İSTANBUL / TURKEY

Tel. 444 71 36

Tel. +90 212 659 03 86

Fax. +90 212 659 03 80

Mail. info@hipas.com.tr

Mail. satis@hipas.com.tr



/HipasPlastik

Tüm yayın hakları saklıdır. Ürün kataloğunda kullanılan fotoğrafların ve resimlerin tamamı yada bir bölümü izin almadan fotokopi, optik veya mekanik herhangi bir yolla kopyalanamaz çoğaltılamaz. Herhangi bir medya ortamında yayınlanamaz.