



BETA MARKA EL ALETLERİ

(İTALYAN)



Türkiye Distribütörü Olduğumuz Beta Profesyonel El Aletlerinin Fiyatları Konusunda,
Lütfen Orjinal Fiyat Listesini Talep Ediniz.

**VAROL
TİCARET**

DÜZ YILDIZ INCH ANAHTAR

Code	inch	€
88 AS	7/16 x 1/2	21,50
88 AS	9/16 x 5/8	26,00



BOMBE BAŞLI T-ALLEN

Code	mm	€
96 LMBP	8	12,70
96 LMBP	10	12,70

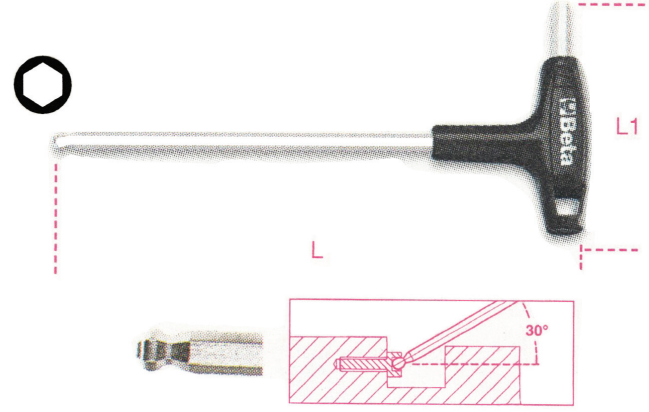

INCH REKOR ANAHTARI

Code	inch	€
94 AS	5/16 x 3/8	13,90
94 AS	3/8 x 7/16	15,10
94 AS	7/16 x 1/2	15,80
94 AS	1/2 x 9/16	16,30
94 AS	5/8 x 3/4	21,10

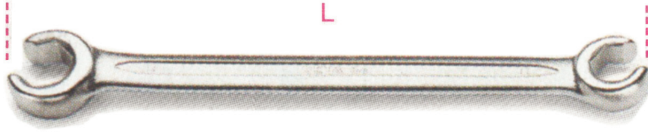

CIRCIRLI TORX ANAHTAR

Code	mm	€
125-TX	6 x 8	34,00
125-TX	10 x 12	34,00



INCH REKOR ANAHTARI TAKIMI

Code	inch	€
94 AS/7		122,50
94 AS	5/16 x 3/8	
94 AS	3/8 x 7/16	
94 AS	7/16 x 1/2	
94 AS	1/2 x 9/16	
94 AS	9/16 x 5/8	
94 AS	5/8 x 3/4	
94 AS	3/4 x 7/8	

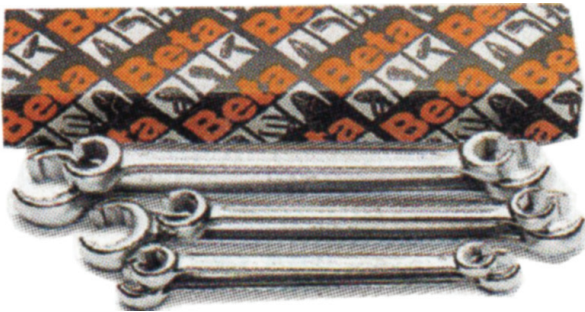

CIRCIRLI ANAHTAR

Code	mm	€
125	12 x 13	38,00



ZİNCİRLİ BORU ANAHTARI

Code	mm	€
386/1 Ø 1"1/2	350	63,00



1/4 MAFSALLI INCH LOKMA

Code	inch	€
900 AS/SN	1/4	33,50
900 AS/SN	3/8	33,50

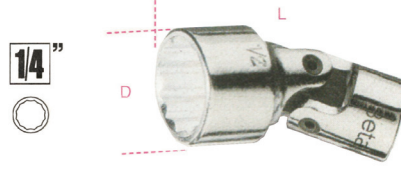

1/4 AYARLI UZATMA

Code	mm	€
900/24	182	24,50



AYARLI KİLİTLİ PENSE

Code	mm	€
390	65	85,00

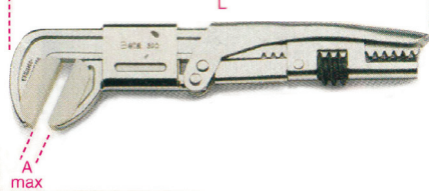

3/8 MAFSAL KOL UZUN

Code	mm	€
910/19	695-3/8 x 3/8	24,50

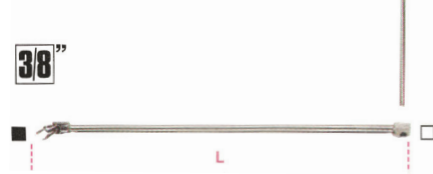

PİPO ANAHTARI

Code	mm	€
938	8	4,80
938	10	5,20



1/4 TORK ANAHTARI

Code	Cnm	€
580/10F	0÷100 1/4 0÷140 02f.in	321,00



3/8 FIRDÖNDÜ KOL

Code	mm	€
910M/46	400	26,75

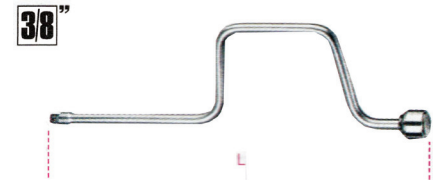

T-LOKMA

Code	mm	€
941	6	14,20
941	7	14,20
941	9	14,70
941	11	14,70

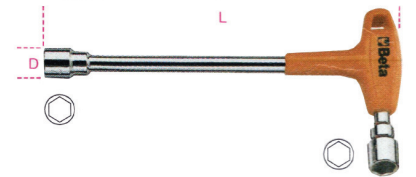

1/4 TORK ANAHTARI

Code	Nm	€
581/1F	0,6÷5,5 1/4	180,00
588, 680, 682		
TORK METRE İLE ÇALIŞIR		



3/8 TORK ANAHTARI KAFASI

Code	inch	€
910 CF/AS	3/8	7,00
910 CF/AS	7/16	7,00
910 CF/AS	1/2	7,90
910 CF/AS	9/16	9,20
910 CF/AS	5/8	10,30
910 CF/AS	11/16	12,00
910 CF/AS	3/4	12,00

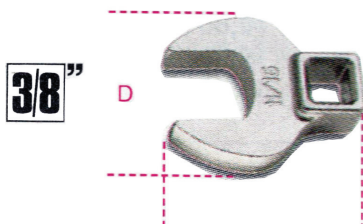

MİNİ LOKMA TORNAVİDA

Code	mm	€
942 BM	13	14,30

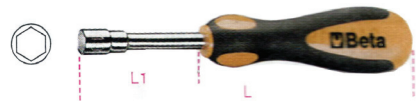

T-LOKMA ANAHTARI (KISA TİP)

Code	mm	€
945	4	8,35
945	9	8,90

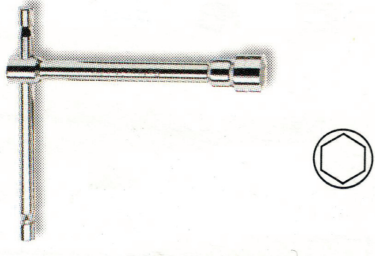

DİZEL ENJEKTÖR LOKMASI

Code	mm	€
960 G	D.27-D1-22	57,00

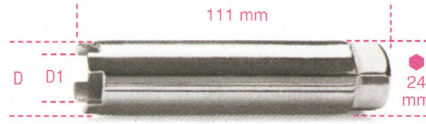

ANTİMANYETİK CIMBIZ

Code	mm	€
995 A	130	10,50



ENJEKTÖR POMPA ANAHTARI

Code	mm	€
960 CP	13	53,00



ANTİMANYETİK CIMBIZ

Code	mm	€
995 B	135	10,50



T-LOKMA ANAHTARI

Code	mm	€
950	20	22,40

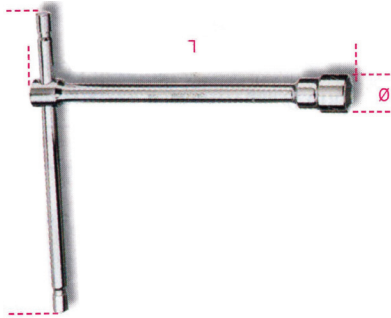

TIRNAKLI LOKMA

Code	mm	€
969	50	134,00

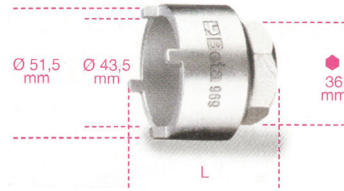

ANTİMANYETİK CIMBIZ

Code	mm	€
995 C	125	10,50

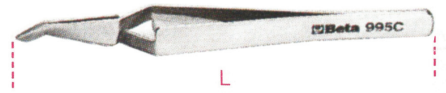

MAFSALLI T-LOKMA UZUN

Code	mm	€
952 L	22	77,00

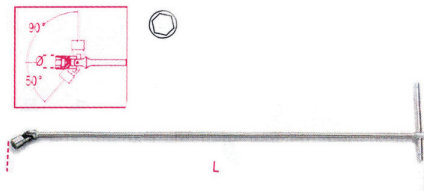

TEKERLEK GÖBEĞİ KİLİTLEME ANAHTARI

Code	mm	€
971	665-15	55,50

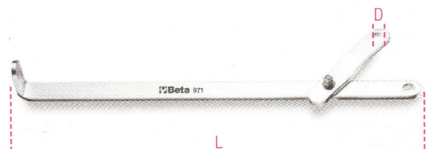

ANTİMANYETİK CIMBIZ

Code	mm	€
999 F	120	10,50



MAFSALLI BUJİ T-LOKMASI UZUN

Code	mm	€
959 L	20,8 = 13/16 750 mm	56,00



BİJON ANAHTARI

Code	mm	€
981	17x19x22x13/16	37,50

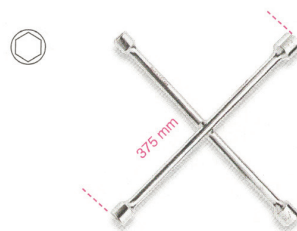

ANTİMANYETİK CIMBIZ

Code	mm	€
999 T/C	130	33,00



UNI /ISO 6788 DIN 3119

DÜZ KARGABURUN

Code	mm	€
1010	140	14,50

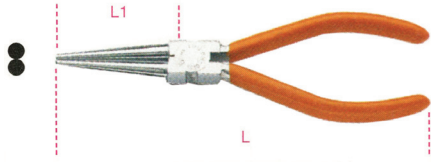

OTOMATİK KABLO SIYIRMA PENSESİ

Code	mm	€
1147 A	0,5÷6	132,50

Kendiliğinden ayarlı
Profesyonel tip

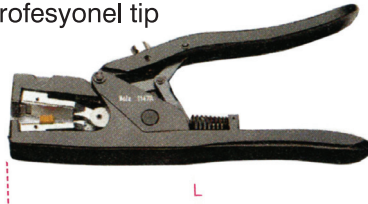

BOMBE BAŞLI TORNAVİDA

Code	mm	€
1216	12	11,40

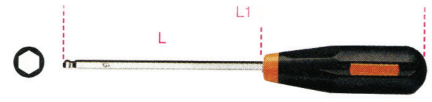

SAC MAKASI

Code	mm	€
1110	L-255 L1-55	24,50

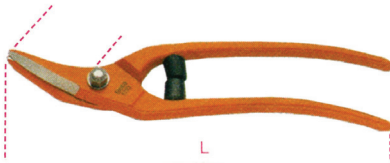

1147 A YEDEK AĞZI

Code	mm	€
1147 RG/A	0,5÷6	37,50

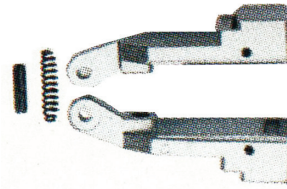

DÜZ KLEMENS TORNAVİDA

Code	mm	€
1227	4x100	3,85
1227	4x150	4,30

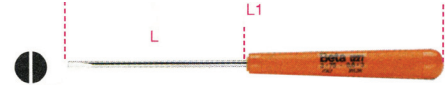

YILDIZ KLEMENS TORNAVİDA

Code	mm	€
1228	4,5x100	4,30

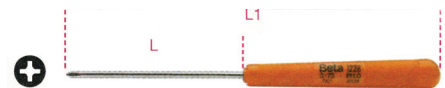

SAC MAKASI

Code	mm	€
1111	L-255 L1-50	24,50

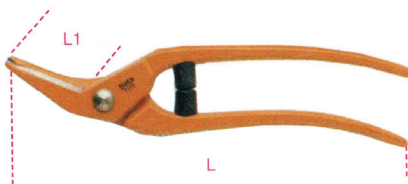

OTOMATİK KABLO SIYIRMA PENSESİ

Code	mm	€
1149	1÷25	186,50

Kendiliğinden ayarlı
Profesyonel tip

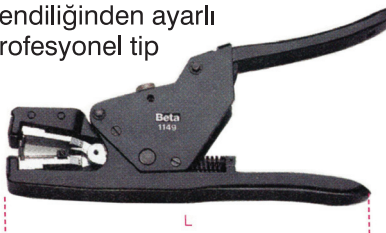

ALLEN TORNAVİDA

Code	mm	€
1240 MQ	5	6,60

△ 1000 V ⊕



KABLO SIYIRMA PENSESİ

Code	mm	€
1144 A	8÷25	105,00

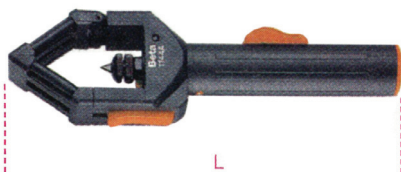

ELEKTRONİKÇİ YAN KESKİ

Code	mm	€
1193	0,5	53,00

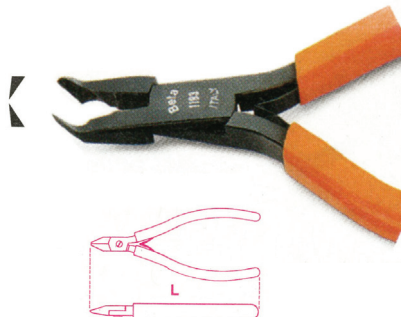

TUTUCULU DÜZ TORNAVİDA

Code	mm	€
1250	2,5 x 75	10,10

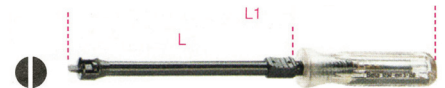

BOMBE BAŞLI TORNAVİDA

Code	mm	€
1293 BP	10	11,00
1293 BP	12	12,80

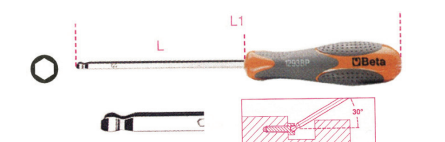

KAPORTACI DAYAMASI

Code	mm	g	€
1301	123	835	35,50

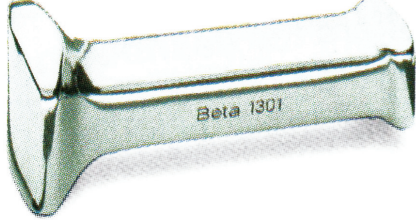

MARANGOZ ÇEKİCİ

Code	mm	€
1376	300	12,00
1376	400	12,50



SİBOP ÇEKTİRMESİ

Code	mm	€
1453 GC	150÷350	146,00

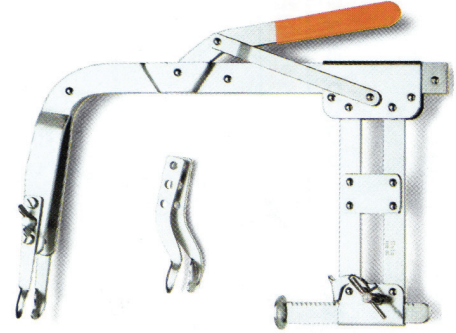

KAPORTACI DAYAMASI

Code	mm	g	€
1311	80	1225	51,00



ÖZEL ANAHTAR YILDIZ

Code	mm	€
1411	13	37,50

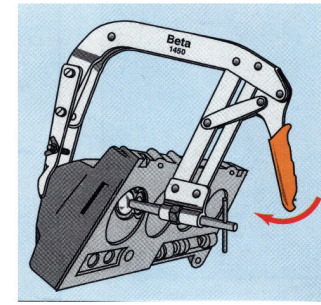
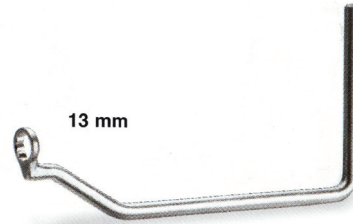

KAPORTACI ÇEKİCİ

Code	mm	€
1355	40 - 32	19,70

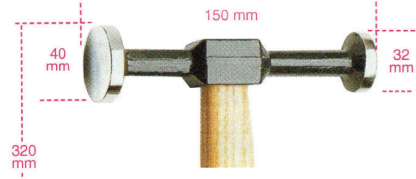

ENJEKTÖR AYAR TORNAVİDASI

Code	mm	L	€
1439	3	377	13,00

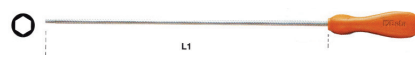

SİBOP PUL PENSESİ

Code	mm	€
1459-45°	200	28,50

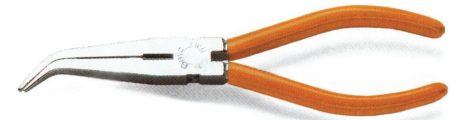

PİSTON KANAL TEMİZLEME

Code	mm	€
1448	50÷175	49,00

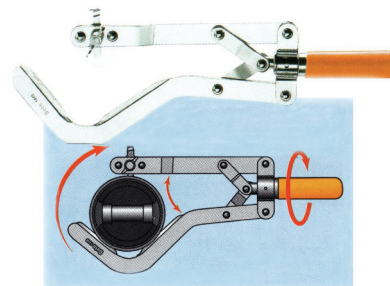

KAPORTACI ÇEKİCİ

Code	mm	€
1359 L	32 - 27	17,50

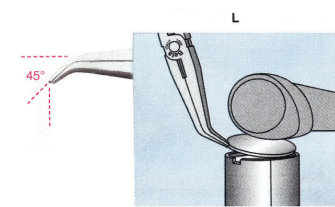
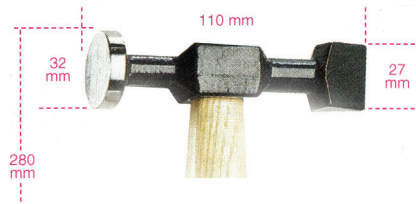

VİTES ANAHTAR TAKIMI

Code	mm	€
1457-S3	L1-220 L2-200	29,00

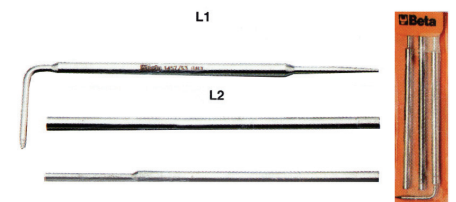

ELEKTRİKÇİ ÇEKİCİ

Code	mm	gr	€
1372	105	100	14,00

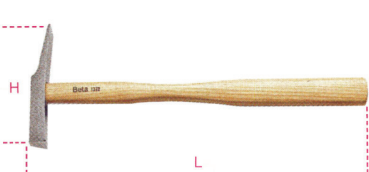

SİBOP ÇEKTİRMESİ

Code	mm	€
1450	75÷225	41,00

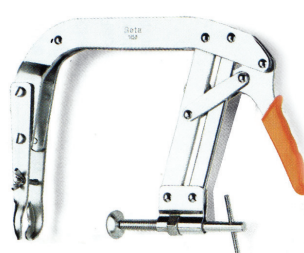

MOTOR SENTE APARATI FIAT İÇİN

Code	€
1461/C2 Benzinli Motorlar için	310,00

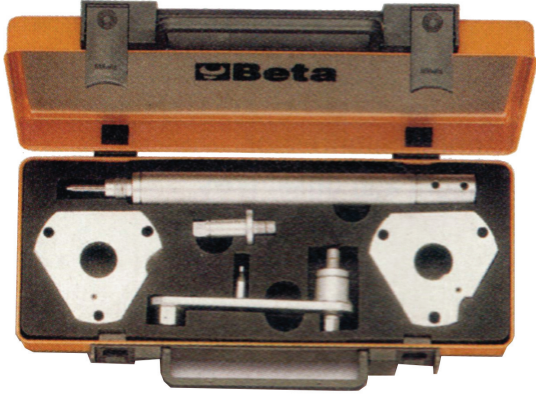

ŞİM PENSESİ

Code	mm	€
1466	275	40,00

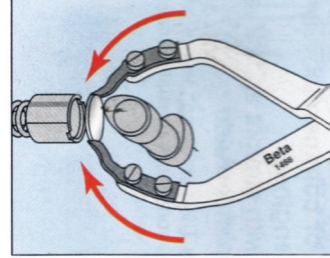

MOTOR SENTE APARATI FIAT-ALFA RO. İÇİN

Code	€
1461/C4 Benzinli+Dizel Motorlar için	72,00

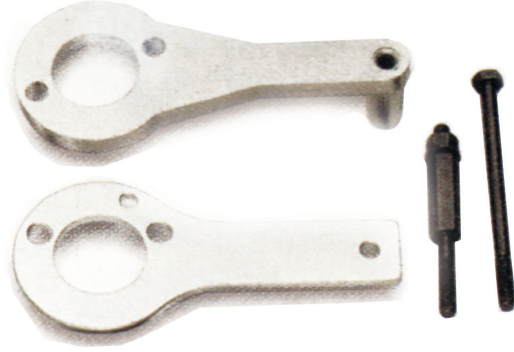

FREN YAY PENSESİ

Code	mm	€
1471G	6	13,50

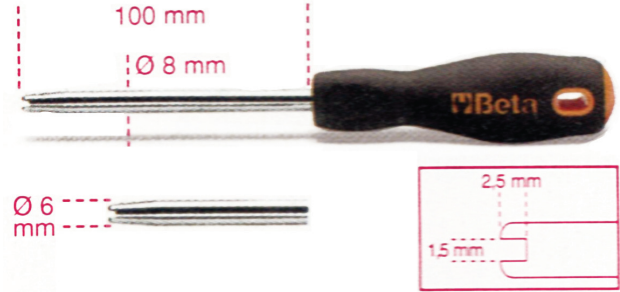

SİBOP YAY SIKIŞTIRMA

Code	mm	€
1462	200	46,50

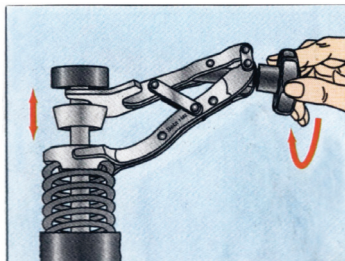

FREN AYAR KOMBİNE ANAHTARI

Code	mm	€
1471CH	25-10-L 260	24,50



BUJİ BAŞLIK PENSESİ

Code	mm	€
1474	200-12,5	49,00

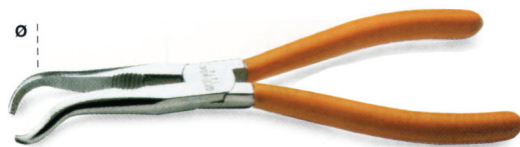

BUJİ BAŞLIK PENSESİ

Code	mm	€
1474 A	210 Ø16	52,00

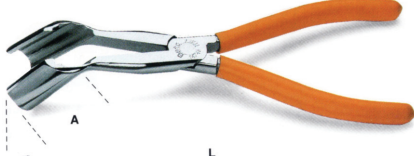

BUJİ BAŞLIK PENSESİ

Code	mm	€
1474 B	235 Ø16	53,00

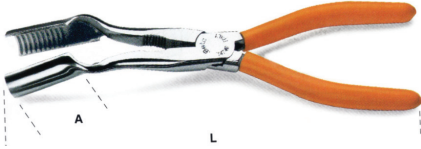

KLİPS TAKIMI

Code	inch	€
1483	5/16 ÷ 7/8	36,50

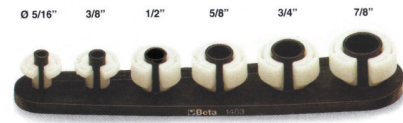

AĞIR TİP FİLTRE SÖKME

Code	inch	€
1493 A	74-8	88,00



AĞIR TİP FİLTRE SÖKME

Code	inch	€
1493 B	74-8	106,00



AĞIR TİP FİLTRE SÖKME

Code	mm	€
1493 C	92-10	93,00



AĞIR TİP FİLTRE SÖKME

Code	mm	€
1493 D	105-15	116,00



KARTER TAPA ANAHTARI TK.

Code	€
1494/C6	76,00



1494	8x10 mm
	8x3/8 mm
	10x11 mm
	12x13 mm
	14x17 mm
	19 mm
1494PB	17 mm x 1/2"

KARTER TAPA ANAHTARI ADAPTÖRÜ

Code	mm	€
1496 PB	17-1/2	7,80



TAS TİP FİLTRE SÖKME

Code	mm	€
1493/L	66-6	21,50
1493/R	96-9	27,00

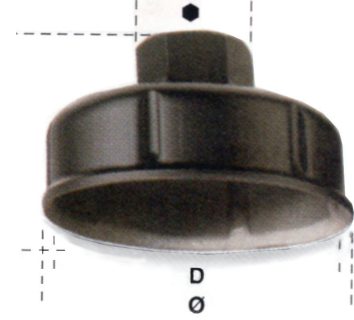

TAS TİP FİLTRE SÖKME

Code	mm	€
1493/E	65-14	10,50
1493/F	74-15	10,50
1493/G	90-15	10,50



KARTER TAPA ANAHTARI

Code	mm	€
1494 T	10	18,60

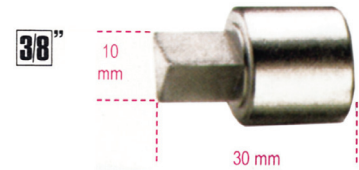

KARTER TAPA ANAHTARI

Code	mm	€
1495	215	27,00



RULMAN ÇEKTİRMESİ AYAĞI

Code	mm					€
	A	L	Ø	Ø	kg	
	mm	mm	mm	mm		
1548/5	270	220	22	1548G4/6÷8	1,10	63,00

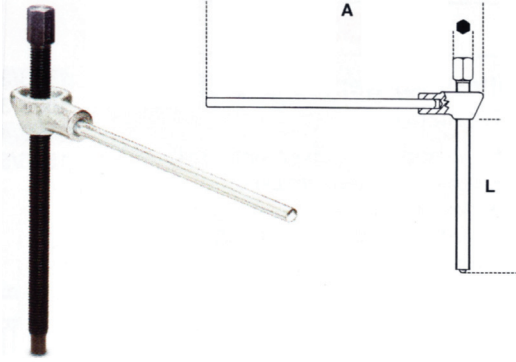

KONNEKTÖR PENSESİ

Code	mm	€
1601	RJ 11 - RJ 12 - 4P - 6P - 9,65	22,50

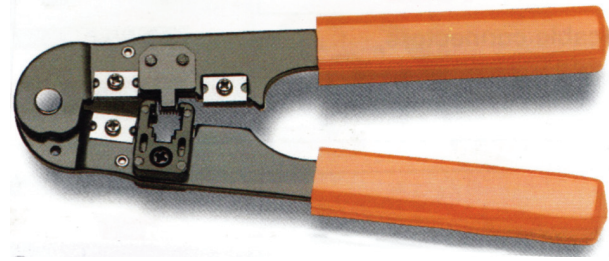

GÖNYE

Code	mm				€
	L	L1	H	S	
	mm	mm	mm	mm	
1665	150	100	25	5,5	89,50

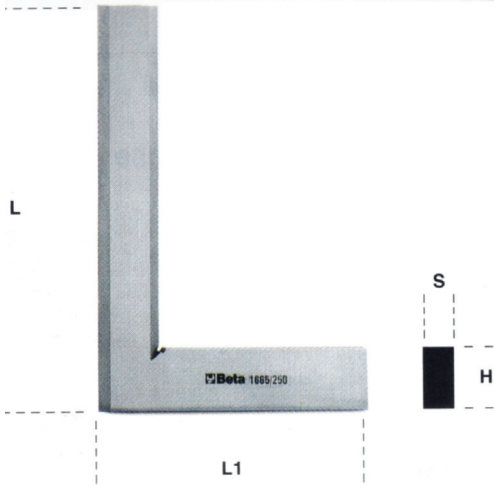

GÖNYE

Code	mm				€
	L	L1	H	S	
	mm	mm	mm	mm	
1666	150	100	24,5	5,5	70,00

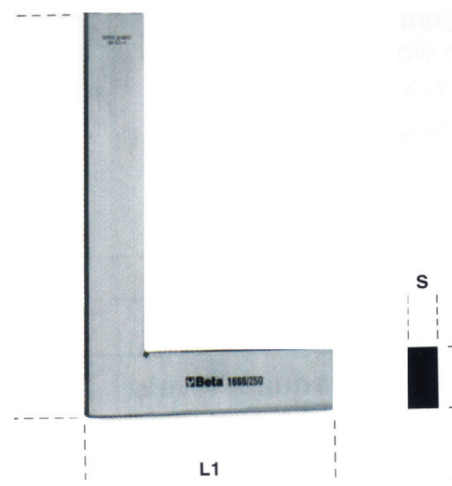

METRE

Code	M	S	€
1694 A	50	14	19,10



INCH SENTİL

Code	inch	L mm	€
1708AS/13	0,002÷0,035	105	4,30



MAKET BIÇAĞI

Code	mm	€
1771 F	155	2,70

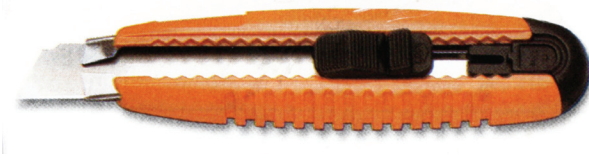

EL FENERİ

Code	mm	€
1835	130	8,50



MAKET BIÇAĞI

Code	mm	€
1772 A	155	7,00



EL FENERİ

Code	mm	€
1835 A	270	49,50



SEYYAR LAMBA

Code	V - W - L	€
1840 B	230 - 60 - 350	98,00



SEYYAR FLORESAN LAMBASI

Code	V - W - L	€
1841	230 - 11 - 450	163,00



SEYYAR FLORESAN LAMBASI

Code	V - W - L	€
1841 A	24 - 11 - 450	172,00



NAYLON KEMER

Code	mm	€
2008	1150	11,00



DERİ ÇEKİÇ ASKISI

Code	mm	€
2007 A	60	10,50

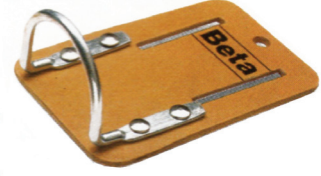
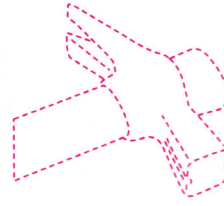

DERİ TAKIM ÇANTASI

Code	cm	€
2010 N/BV	57 x 26 x 37	361,00



DERİ TAKIM ÇANTASI

Code	cm	€
2010/BV	50 x 24 x 40	430,00



ALETLİ TAKIM ÇANTASI

Code	pcs	€
2050 A	27	263,00



34	12	2
55	2	5
55AS	2	5
96	3	5
110	2	8
957	18	21
1044	7	9
1084	7	11
1150	7	7
1205	9	1
1210	9	1
1370	12	4
1490/1	18	17
1725CR	13	11
1737	18	22

ALETLİ TAKIM ÇANTASI

Code	pcs	€
2055 A	18	95,50



60 mm	55	2	5
	96	3	5
	1151	7	8
	1205	9	1
230 mm	1210	9	1
335 mm	1370	12	4
	1755	22	2

TAKIM ARABASI

Code

CM 24 - 7-Çekmeceli-700 X 880 X 440

€

550,00

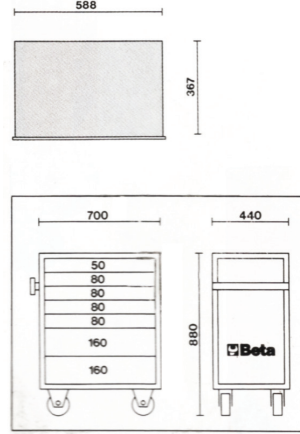

TAKIM ARABASI

Code

CX 24 - 5-Çekmeceli-700 X 880 X 440

€

540,00

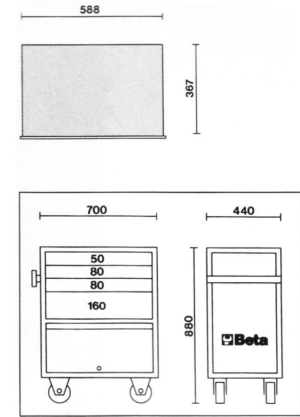

TAKIM ARABASI

Code

C 27 - 3-Çekmeceli-720 X 900 X 380

€

524,00

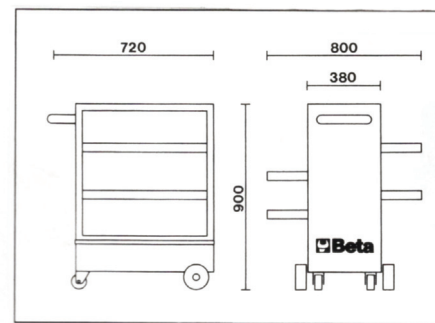



JAPON OTOMATİK PAFTA TARAK ve KAFALARI

OTOMATİK PAFTA TARAKLARI (OSG - JAPON)

H 1	93,00 €
H 2	93,00 €
H 3	118,00 €
H 4	140,00 €
H 5	255,00 €

OTOMATİK PAFTA TARAKLARI (RKF - INDIA)

H 2	82,00 €
H 3	114,00 €
H 4	158,00 €
H 5	217,00 €

OTOMATİK PAFTA KAFALARI (TACO - INDIA)

H 1	783,00 €
H 2	783,00 €
H 3	1.073,00 €
H 4	1.378,00 €
H 5	1.885,00 €